



**COOKING APPLIANCES
ALWAYS MOVING FORWARD**

Can

An *AIRXCEL* Brand



An *AIRXCEL* Brand



COMPANY

The Italian brand in the most beautiful travelling kitchens

CAN is the Italian manufacturer of hobs and sinks whose products can be found off the most exclusive coastlines, and in the heart of the wildest landscapes.

For over 30 years yacht and leisure vehicles manufacturers have chosen CAN to help realise their kitchen ideas, achieved through close collaboration between the respective designers, with a reliable supply chain and a high product quality standard that is never broken.

Many great brands from both the nautical and recreational vehicle markets have found CAN to be an exceptional partner. Authoritative references demonstrate how CAN has, and continues to be successful in bringing the excellence of Italian design to appliances within galleys and recreational vehicle kitchens, helping them to become the most sought after Italian company in the industry, most requested, most popular.

With the growth of CAN ever increasing, the objectives of CAN for the future remain, aiming to serve a market in constant evolution and expansion.

In 2017, CAN has done huge investments in new “moulds” and machinery giving birth to a new range of innovative products to keep its appliances always updated to the last customers’ needs and tendencies.

CAN Designers and Researchers have worked in close contact to develop brand new built-in kitchens and innovative cooktops with amazing features.



Customised solutions Unique. Just as whoever cooks

Materials of all kinds are moulded through Italian design into a variety of shapes and designs. CAN interprets the specific needs of every market, sector, and customer.

This enables it to offer a range of versatile solutions that in turn can be customised upon request. Be it stainless steel or glass, elliptical, square, round or irregular shapes, combined or dedicated units.

Whether gas, induction, alcohol or ethanol burners, CAN will endeavour to meet every request with the most effective solution.
Customised. Unique.





For a professional kitchen Always. Everywhere

For over thirty years CAN have stood for quality within the kitchen for the marine market. Supplying Hobs and Sinks with professional performances, designed for those who, even whilst travelling, wish to cook just as they would at home.

Accurate adjustment of power and even cooking are guideline objectives for CAN, without ever compromising the practicality, compactness or safety of the appliance.

This method of design and manufacture that today meets even the recreational vehicle market, making CAN the reference brand for all professional kitchens away from home.

GIMBALLING BUILT-IN COOKERS AND OVENS

| | | | | | |
|--------|----|--------|----|--------|----|
| CU2000 | 12 | CU1000 | 14 | FO2010 | 16 |
| CU3000 | 13 | FO5010 | 15 | | |

CRYSTAL

| | | | | | |
|--------|----|--------|----|--------|----|
| PV1251 | 20 | PV1351 | 24 | PV1364 | 28 |
| PV1256 | 21 | PV1352 | 25 | PV1366 | 29 |
| PV1320 | 22 | PV1357 | 26 | | |
| PV1350 | 23 | PV1360 | 27 | | |

HOODINY

| | | | | | |
|--------|----|--------|----|--------|----|
| FC1345 | 32 | FC1343 | 36 | FC1351 | 40 |
| FC1348 | 33 | FC1344 | 37 | FC1362 | 41 |
| FC1336 | 34 | FC1347 | 38 | FC1363 | 42 |
| FC1346 | 35 | FC1350 | 39 | | |

RANDI COMBINATION UNIT

| | | | | | |
|--------|----|--------|----|---------|----|
| FL1323 | 46 | FL1502 | 50 | FL1770 | 54 |
| FL1324 | 47 | FL1510 | 51 | FL1780 | 55 |
| FL1500 | 48 | FL1765 | 52 | FL1922R | 56 |
| FL1501 | 49 | FL1766 | 53 | FL1922L | 57 |

SLIDE OUT - PORTABLE KITCHEN

| | |
|--------|----|
| SL1323 | 60 |
| SL1400 | 61 |

HOTTY

| | | | |
|--------|----|--------|----|
| PC1320 | 66 | PC1322 | 68 |
| PC1321 | 67 | PC1323 | 69 |

FOLDY

| | |
|--------|----|
| LC1701 | 72 |
| LC1710 | 73 |

ELECTRICAL COOKING UNITS

| | | | | | |
|--------|----|--------|----|--------|----|
| PI3050 | 76 | PT1358 | 78 | PB1328 | 80 |
| PT1356 | 77 | PB1327 | 79 | PTS121 | 81 |

SINKS WITH FAUCET

| | | | | | |
|--------|----|--------|----|--------|----|
| LR1375 | 84 | LR1760 | 86 | LR1770 | 88 |
| LR1405 | 85 | LR1762 | 87 | | |

SINKS

| | | | | | |
|--------|----|--------|----|----------|----|
| LA1400 | 92 | LA1405 | 94 | LA1418BA | 97 |
| LA1401 | 92 | LA1410 | 95 | LA1403BA | 97 |
| LA1402 | 93 | LA1411 | 95 | | |
| LA1403 | 93 | LA1417 | 96 | | |
| LA1404 | 94 | LA1418 | 96 | | |

OUTDOOR

| | | | |
|--------|-----|--------|-----|
| FN1330 | 100 | FN1333 | 101 |
| FN1332 | 100 | | |

URBAN HYBRID

| | | | |
|---------|-----|--------|-----|
| HC0550 | 104 | HC0770 | 106 |
| HC0635T | 105 | | |

ACCESSORIES

| | | | | | |
|--------|-----|--------|-----|--------|-----|
| LP1600 | 110 | RB1485 | 112 | RB1492 | 114 |
| LP1601 | 110 | RB1486 | 112 | RB1493 | 114 |
| LP1602 | 110 | RB1487 | 112 | RB1853 | 114 |
| LP1610 | 111 | RB1488 | 113 | LP5600 | 115 |
| LP1800 | 111 | RB1490 | 113 | LP5300 | 115 |
| LP1000 | 111 | RB1491 | 113 | LP5410 | 115 |

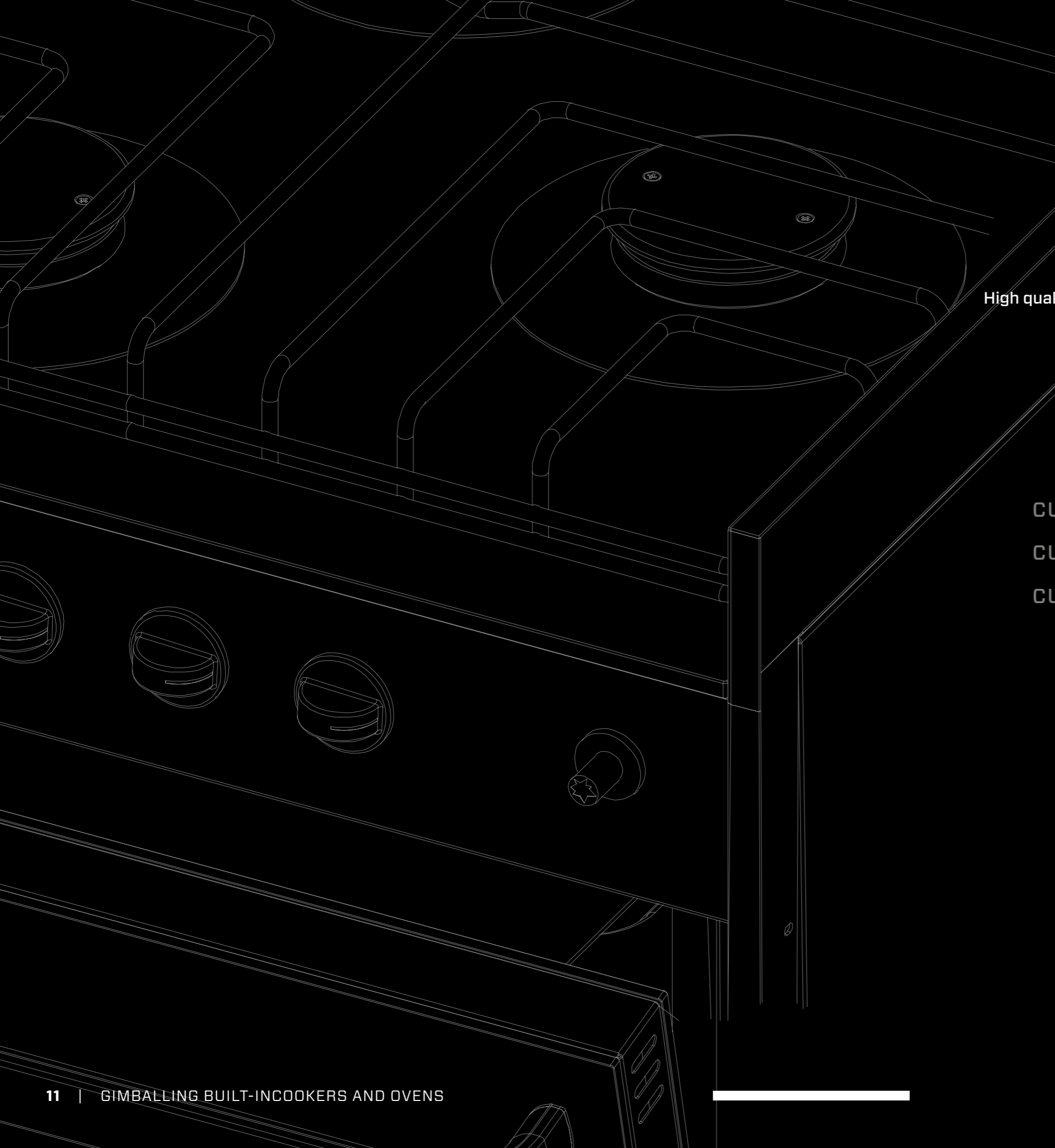

GIMBALLING BUILT-IN COOKERS AND OVENS

Gas cookers and ovens

High quality built-in and gimbal cookers, with oven and grill, made entirely of stainless steel. Design, Quality and Performance.

| | | | |
|--------|----|--------|----|
| CU2000 | 12 | F05010 | 15 |
| CU3000 | 13 | F02010 | 16 |
| CU1000 | 14 | | |



CU2000

High Quality marine cooker, 2 burners with gimbal.

Gas cooker with 30 lt oven capacity in stainless steel, equipped with a 2-burner toughened black glass cooker hob; incl. gimbal assembly kit.

| | |
|--------------------|--|
| Numbers of burner | 2 + Oven |
| Dimension | 500x410x458 mm |
| Power | A 1 kW / SR 1.7 kW / Forno 1.9 kW |
| Energy Consumption | (A 73g/h) (SR 124g/h) (Forno 152 g/h) |
| Supply gas | GPL 28-30 mbar |
| Safety device | Thermocouple |
| Weight | 22 Kg |
| Power On | Oven: Piezo electric Burners: Manual lighting |



CU3000

High Quality marine cooker, 3 burners with gimbal.

Gas cooker with oven 30 lt capacity in stainless steel, equipped with a 3-burner stove in tempered black glass; incl. gimbal assembly kit.

| | |
|--------------------|--|
| Numbers of burner | 3 + Oven |
| Dimension | 500x410x458 mm |
| Power | A1kW / SR1.7kW / SR 1.7 kW Forno 1.9 kW |
| Energy Consumption | (A 73g/h) (SR 124g/h) (Forno 152 g/h) |
| Supply gas | GPL 28-30 mbar |
| Safety device | Thermocouple |
| Weight | 23 Kg |
| Power On | Oven: Piezo electric Burners: Manual |



PACKAGE DIMENSION
500X600X520 mm



PACKAGE WEIGHT
30 Kg



PACKAGES FOR PALLET
12 (114X114X175) 375 Kg



PACKAGE DIMENSION
500X600X520 mm



PACKAGE WEIGHT
31 Kg



PACKAGES FOR PALLET
12 (114X114X175) 375 Kg



DOWNLOAD
MANUAL
INSTRUCTIONS



DOWNLOAD
MANUAL
INSTRUCTIONS

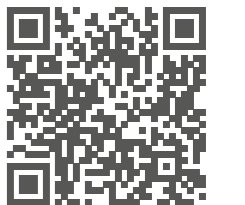



CU1000

High Quality marine cooker, 2 burners with gimbal.

Gas cooker with 19 lt oven capacity in stainless steel, equipped with a 2-burner stove incorporated. Incl. gimbal assembly kit.

| | |
|--------------------|---------------------------------------|
| Numbers of burner | 2 + Oven + Grill |
| Dimension | 450x315x485 mm |
| Power | A 1 kW / SR 1.7 kW / Forno 1.9 kW |
| Energy Consumption | (A 73g/h) (SR 124g/h) (Forno 152 g/h) |
| Supply gas | GPL 28-30 mbar |
| Safety device | Thermocouple |
| Weight | 17,5 Kg |
| Power On | Oven & Burners: Manual lighting |

 **PACKAGE DIMENSION**
570X440X490 mm

 **PACKAGE WEIGHT**
20 Kg

 **PACKAGES FOR PALLET**
16 (80X120X220) 330Kg





F05010

High Quality built-in gas Oven with grill, 30 liters

Stainless-steel built-in gas oven with grill, equipped by electric 12 V ignition and door with see through window. Oven and grill burner managed by a thermostatic gas valve with flame failure safety device. 30 liters oven capacity with efficient 1,90 kW burner and a unique 1,80 kW grill burner!

| | |
|--------------------|----------------------------------|
| Number of burners | Oven and Grill |
| Dimension | 457x370x430mm |
| Power | Oven 1.9 kW / Grill 1.8 kW |
| Energy Consumption | (Oven 152 g/h) (Grill 125.5 g/h) |
| Supply gas | GPL 28-30 mbar |
| Safety device | Thermocouple |
| Weight | 22 Kg |
| Power On | Electric 12v |

 **PACKAGE DIMENSION**
500X600X520 mm

 **PACKAGE WEIGHT**
23 Kg

 **PACKAGES FOR PALLET**
12 (114X114X175) 273 Kg

| PRODUCT | | FEATURES / SPECIFICATIONS / ACCESSORIES | | |
|---------|----------|---|-------|-------------|
| MODEL | IGNITION | VERSION | GRILL | ART. NUMBER |
| CU1000 | S | | — | CU1000-S |
| CU1000 | S | G | ● | CU1000-S-G |

S MANUAL LIGHTING | P PIEZOMECHANIC IGNITION | E 12V ELECTRONIC IGNITION



DISCOVER
MORE AT
AIRXCEL.EU



DOWNLOAD
MANUAL
INSTRUCTIONS





F02010

High Quality built-in gas Oven with grill, 20 liters.

Stainless-steel built-in gas oven with grill, equipped by electric 12 V ignition and door with see through window. Oven and grill burner managed by a thermostatic gas valve with flame failure safety device. 20 liters oven capacity with efficient 1,90 kW burner and a unique 1,80 kW grill burner!

| | |
|--------------------|----------------------------------|
| Number of burners | Oven and Grill |
| Dimension | 530x410x320 mm |
| Power | Oven 1.9 kW / Grill 1.8 kW |
| Energy Consumption | (Oven 152 g/h) (Grill 125.5 g/h) |
| Supply gas | GPL 28-30 mbar |
| Safety device | Thermocouple |
| Weight | 16,5 Kg |
| Power On | Electric 12v |
| Markings | CE |



PACKAGE DIMENSION
600X500X400 mm



PACKAGE WEIGHT
18 Kg



PACKAGES FOR PALLET
20 (120X120X220) 370Kg



DISCOVER
MORE AT
[AIRXCEL.EU](https://www.airxcel.eu)



CRYSTAL

Hobs meet glass

Crystal was born through seeking new solutions: a line of hobs that utilizes glass as the principle material of the kitchen. Thus, the stainless steel components shine on special scratch-resistant surfaces, in sizes fully customisable, making Crystal the answer for those who wish to go beyond the ordinary, without restraint. What is the secret? Italian designed with maximum care taken over every detail.

| | | | |
|--------|----|--------|----|
| PV1251 | 20 | PV1352 | 25 |
| PV1256 | 21 | PV1357 | 26 |
| PV1320 | 22 | PV1360 | 27 |
| PV1350 | 23 | PV1364 | 28 |
| PV1351 | 24 | PV1366 | 29 |

PV1251

Rectangular glass top N°2 burners A-SR.

Built-in rectangular stove in scratch-resistant tempered glass, 2-burner gas supply with A-SR burners.



| | |
|--------------------|-----------------------|
| Number of burners | 2 |
| Dimension | 380x280 mm |
| Power | A 1 kW / SR 1.7 kW |
| Energy Consumption | (A 73g/h) (SR 124g/h) |
| Supply gas | GPL 28-30 mbar |
| Safety device | Thermocouple |
| Material | Tempered glass 8 mm |
| Weight | 6 Kg |



PACKAGE DIMENSION
560X430X180 mm



PACKAGE WEIGHT
8 Kg



PACKAGES FOR PALLET
36 (90x120x180) 300 Kg

| PRODUCT | | | FEATURES / SPECIFICATIONS / ACCESSORIES | | |
|---------|----------|---------|---|------------------|-------------|
| MODEL | IGNITION | VERSION |  | SINGLE PACKAGING | ART. NUMBER |
| PV1251 | E | | 12V ELECTRONIC IGNITION | — | PV1251-E |
| PV1251 | E | GR | | ● | PV1251-E-GR |

S MANUAL LIGHTING | P PIEZOMECHANIC IGNITION | E 12V ELECTRONIC IGNITION



DISCOVER
MORE AT
AIRXCEL.EU



PV1256

Rectangular glass top N°2 burners A-SR.

Built-in rectangular stove in scratch-resistant tempered glass, 2-burner gas supply with A-SR burners.



| | |
|--------------------|-----------------------|
| Number of burners | 2 |
| Dimension | 280x380 mm |
| Power | A 1 kW / SR 1.7 kW |
| Energy Consumption | (A 73g/h) (SR 124g/h) |
| Supply gas | GPL 28-30 mbar |
| Safety device | Thermocouple |
| Material | Tempered glass 8 mm |
| Weight | 6 Kg |



PACKAGE DIMENSION
560X430X180 mm



PACKAGE WEIGHT
8 Kg



PACKAGES FOR PALLET
36 (90x120x180) 300 Kg

| PRODUCT | | | FEATURES / SPECIFICATIONS / ACCESSORIES | | |
|---------|----------|---------|---|------------------|-------------|
| MODEL | IGNITION | VERSION |  | SINGLE PACKAGING | ART. NUMBER |
| PV1256 | E | | 12V ELECTRONIC IGNITION | — | PV1256-E |
| PV1256 | E | GR | | ● | PV1256-E-GR |

S MANUAL LIGHTING | P PIEZOMECHANIC IGNITION | E 12V ELECTRONIC IGNITION



DISCOVER
MORE AT
AIRXCEL.EU



PV1320

Square glass top N°1 burner SR.

Built-in square stove in scratch-resistant tempered glass, 1-burner gas supply. There is a special sleeve placed on the top of the unit that is used as a seat for the column type pan-holder.

| | |
|--------------------|---------------------|
| Number of burners | 1 |
| Dimension | 290x325 mm |
| Power | SR 1.7 kW |
| Energy Consumption | (SR 124g/h) |
| Supply gas | GPL 28-30 mbar |
| Safety device | Thermocouple |
| Material | Tempered glass 8 mm |
| Weight | 5 Kg |



PACKAGE DIMENSION
435X360X180 mm



PACKAGE WEIGHT
7 Kg



PACKAGES FOR PALLET
40 (90x120x180) 290 Kg

| PRODUCT | | | FEATURES / SPECIFICATIONS / ACCESSORIES | | |
|---------|----------|---------|---|------------------|-------------|
| MODEL | IGNITION | VERSION | MANUAL LIGHTING | SINGLE PACKAGING | ART. NUMBER |
| PV1320 | S | | ● | — | PV1320-S |
| PV1320 | S | GR | ● | ● | PV1320-S-GR |

S MANUAL LIGHTING | P PIEZOMECHANIC IGNITION | E 12V ELECTRONIC IGNITION



DISCOVER
MORE AT
AIRXCEL.EU



PV1350

Rectangular glass top N°1 burner SR.

Built-in rectangular stove in scratch-resistant tempered glass, 1-burner gas supply. There is a special sleeve placed on the top of the unit that is used as a seat for the column type pan-holder.

| | |
|--------------------|---------------------|
| Number of burners | 1 |
| Dimension | 200x365 mm |
| Power | SR 1.7 kW |
| Energy Consumption | (SR 124g/h) |
| Supply gas | GPL 28-30 mbar |
| Safety device | Thermocouple |
| Material | Tempered glass 8 mm |
| Weight | 5 Kg |



PACKAGE DIMENSION
435X360X180 mm



PACKAGE WEIGHT
7 Kg



PACKAGES FOR PALLET
40 (90x120x180) 290 Kg

| PRODUCT | | | FEATURES / SPECIFICATIONS / ACCESSORIES | | |
|---------|----------|---------|---|------------------|-------------|
| MODEL | IGNITION | VERSION | MANUAL LIGHTING | SINGLE PACKAGING | ART. NUMBER |
| PV1350 | S | | ● | — | PV1350-S |
| PV1350 | S | GR | ● | ● | PV1350-S-GR |

S MANUAL LIGHTING | P PIEZOMECHANIC IGNITION | E 12V ELECTRONIC IGNITION



DISCOVER
MORE AT
AIRXCEL.EU



PV1351

Rectangular glass top N°2 burners A-SR.

Built-in rectangular stove in scratch-resistant tempered glass, 2-burner gas supply with A-SR burners. There is a special sleeve placed on the top of the unit that is used as a seat for the column type pan-holder.

| | |
|--------------------|-----------------------|
| Number of burners | 2 |
| Dimension | 380x280 mm |
| Power | A 1 kW / SR 1.7 kW |
| Energy Consumption | (A 73g/h) (SR 124g/h) |
| Supply gas | GPL 28-30 mbar |
| Safety device | Thermocouple |
| Material | Tempered glass 8 mm |
| Weight | 6 Kg |



PACKAGE DIMENSION
560X430X180 mm



PACKAGE WEIGHT
8 Kg



PACKAGES FOR PALLET
36 (90x120x180) 300 Kg

| PRODUCT | | | FEATURES / SPECIFICATIONS / ACCESSORIES | | |
|---------|----------|---------|---|------------------|-------------|
| MODEL | IGNITION | VERSION | MANUAL LIGHTING | SINGLE PACKAGING | ART. NUMBER |
| PV1351 | S | | ● | — | PV1351-S |
| PV1351 | S | GR | ● | ● | PV1351-S-GR |

S MANUAL LIGHTING | P PIEZOMECHANIC IGNITION | E 12V ELECTRONIC IGNITION



DISCOVER
MORE AT
AIRXCEL.EU



PV1352

Rectangular glass top N°3 burners A-SR-R.

Built-in rectangular stove in scratch-resistant tempered glass, 3-burner gas supply with A-SR burners. There is a special sleeve placed on the top of the unit that is used as a seat for the column type pan-holder.

| | |
|--------------------|----------------------------------|
| Number of burners | 3 |
| Dimension | 420x370 mm |
| Power | A 1 kW / SR 1.7 kW / R 3,0 kW |
| Energy Consumption | (A 73g/h) (SR 124g/h) (R 218g/h) |
| Supply gas | GPL 28-30 mbar |
| Safety device | Thermocouple |
| Material | Tempered glass 8 mm |
| Weight | 8 Kg |



PACKAGE DIMENSION
560X430X180 mm



PACKAGE WEIGHT
10 Kg



PACKAGES FOR PALLET
36 (90x120x180) 370 Kg

| PRODUCT | | | FEATURES / SPECIFICATIONS / ACCESSORIES | | |
|---------|----------|---------|---|------------------|-------------|
| MODEL | IGNITION | VERSION | MANUAL LIGHTING | SINGLE PACKAGING | ART. NUMBER |
| PV1352 | S | | ● | — | PV1352-S |
| PV1352 | S | GR | ● | ● | PV1352-S-GR |

S MANUAL LIGHTING | P PIEZOMECHANIC IGNITION | E 12V ELECTRONIC IGNITION



DISCOVER
MORE AT
AIRXCEL.EU





PV1357

Rectangular glass top N°2 burners SR-R.

Built-in rectangular stove in scratch-resistant tempered glass, 2-burner gas supply with SR-R burners. There is a special sleeve placed on the top of the unit that is used as a seat for the column type pan-holder.

| | |
|--------------------|------------------------|
| Number of burners | 2 |
| Dimension | 300x500 mm |
| Power | SR 1,9 kW / R 3,0 kW |
| Energy Consumption | (SR 124g/h) (R 218g/h) |
| Supply gas | GPL 28-30 mbar |
| Safety device | Thermocouple |
| Material | Tempered glass 8 mm |
| Weight | 7 Kg |



PACKAGE DIMENSION
560X430X180 mm



PACKAGE WEIGHT
9 Kg



PACKAGES FOR PALLET
40 (90x120x180) 370 Kg

| PRODUCT | | | FEATURES / SPECIFICATIONS / ACCESSORIES | | |
|---------|----------|---------|---|------------------|-------------|
| MODEL | IGNITION | VERSION | MANUAL LIGHTING | SINGLE PACKAGING | ART. NUMBER |
| PV1357 | S | | ● | — | PV1357-S |
| PV1357 | S | GR | ● | ● | PV1357-S-GR |

S MANUAL LIGHTING | P PIEZOMECHANIC IGNITION | E 12V ELECTRONIC IGNITION



DISCOVER
MORE AT
AIRXCEL.EU



PV1360

Gas hob unit with round sink N°2 burners SR-SR.

Built-in rectangular stove in scratch-resistant tempered glass, 2-burner gas supply with SR-SR burners, complete with round stainless steel sink (LA1417). There is a special sleeve placed on the top of the unit that is used as a seat for the column type pan-holder. Option to mount a tap inside the sink or on the top of the cooker.

| | |
|--------------------|-------------------------|
| Number of burners | 2 |
| Dimension | 600x420 mm |
| Power | SR 1,9 kW / SR 1,9 kW |
| Energy Consumption | (SR 124g/h) (SR 124g/h) |
| Supply gas | GPL 28-30 mbar |
| Safety device | Thermocouple |
| Material | Tempered glass 8 mm |
| Weight | 8,5 Kg |



PACKAGE DIMENSION
680X480X260 mm



PACKAGE WEIGHT
10 Kg



PACKAGES FOR PALLET
16 (90x120x180) 170 Kg

| PRODUCT | | | FEATURES / SPECIFICATIONS / ACCESSORIES | | |
|---------|----------|---------|---|------------------|-------------|
| MODEL | IGNITION | VERSION | MANUAL LIGHTING | SINGLE PACKAGING | ART. NUMBER |
| PV1360 | S | | ● | — | PV1360-S |
| PV1360 | S | GR | ● | ● | PV1360-S-GR |

S MANUAL LIGHTING | P PIEZOMECHANIC IGNITION | E 12V ELECTRONIC IGNITION



DISCOVER
MORE AT
AIRXCEL.EU



PV1364

Gas hob unit with semispheric sink N°2 burners A-SR.

Built-in rectangular stove in scratch-resistant tempered glass, 2-burner gas supply with A-SR burners, complete with round stainless steel sink and tap mounted directly on the glass stove. There is a special sleeve placed on the top of the unit that is used as a seat for the column type pan-holder.

| | |
|--------------------|-----------------------|
| Number of burners | 2 |
| Dimension | 788x314 mm |
| Power | A 1 kW / SR 1.7 kW |
| Energy Consumption | (A 73g/h) (SR 124g/h) |
| Supply gas | GPL 28-30 mbar |
| Safety device | Thermocouple |
| Material | Tempered glass 8 mm |
| Weight | 8 Kg |







PACKAGE DIMENSION
1050X500X285 mm



PACKAGE WEIGHT
10 Kg



PACKAGES FOR PALLET
16 (114x114x180) 170 Kg

| PRODUCT | | | FEATURES / SPECIFICATIONS / ACCESSORIES | | | | | | |
|---------|----------|---------|---|---|---|--|---|------------------|-------------|
| MODEL | IGNITION | VERSION | MANUAL LIGHTING |  600025 RUBBER SEAL |  WASTE LP1800 |  RB1487 COLD WATER |  RB1488 HOT AND COLD WATER | SINGLE PACKAGING | ART. NUMBER |
| PV1364 | S | | ● | — | — | — | — | — | PV1364-S |
| PV1364 | S | GR | ● | — | ● | — | — | ● | PV1364-S-GR |

S MANUAL LIGHTING | P PIEZOMECHANIC IGNITION | E 12V ELECTRONIC IGNITION



DISCOVER
MORE AT
AIRXCEL.EU



PV1366

Gas hob unit with semispheric sink N°2 burners A-SR.

Built-in rectangular stove in scratch-resistant tempered glass, 2-burner gas supply with A-SR burners, complete with round stainless steel sink and tap mounted directly on the glass stove. There is a special sleeve placed on the top of the unit that is used as a seat for the column type pan-holder.

| | |
|--------------------|-----------------------|
| Number of burners | 2 |
| Dimension | 788x314 mm |
| Power | A 1 kW / SR 1.7 kW |
| Energy Consumption | (A 73g/h) (SR 124g/h) |
| Supply gas | GPL 28-30 mbar |
| Safety device | Thermocouple |
| Material | Tempered glass 8 mm |
| Weight | 8 Kg |





PACKAGE DIMENSION
1050X500X285 mm



PACKAGE WEIGHT
10 Kg



PACKAGES FOR PALLET
16 (114x114x180) 170 Kg

| PRODUCT | | | FEATURES / SPECIFICATIONS / ACCESSORIES | | | | | | |
|---------|----------|---------|---|---|---|--|--|------------------|-------------|
| MODEL | IGNITION | VERSION | MANUAL LIGHTING |  600025 RUBBER SEAL |  WASTE LP1800 |  RB1487 COLD WATER |  RB1488 HOT AND COLD WATER | SINGLE PACKAGING | ART. NUMBER |
| PV1366 | S | | ● | — | — | — | — | — | PV1366-S |
| PV1366 | S | GR | ● | — | ● | — | — | ● | PV1366-S-GR |

S MANUAL LIGHTING | P PIEZOMECHANIC IGNITION | E 12V ELECTRONIC IGNITION



DISCOVER
MORE AT
AIRXCEL.EU



Linearity and compactness in the kitchen

To meet the natural lines of a kitchen whilst keeping the overall dimensions to a minimum, CAN offers Hoodiny: hobs with a special tempered glass cover. The closing of the lid allows the stove to be hidden whilst creating new, useful table tops. No surprises: to protect the glass from impacts, the hinge enables a slow and soft closing.

| | | | |
|--------|----|--------|----|
| FC1345 | 32 | FC1347 | 38 |
| FC1348 | 33 | FC1350 | 39 |
| FC1336 | 34 | FC1351 | 40 |
| FC1346 | 35 | FC1362 | 41 |
| FC1343 | 36 | FC1363 | 42 |
| FC1344 | 37 | | |



FC1345

Round gas hob-unit N°1 burner SR.



Rounded built-in stove, made from stainless steel, 1-burner gas supply equipped with self-locking lid, stainless steel support grid fixed with anti-vibration rubber pads. Tempered black glass lid with concealed hinges.

| | |
|--------------------|-------------------------|
| Numbers of burners | 1 |
| Dimension | Ø 340 mm |
| Power | SR 1.7 kW |
| Energy Consumption | (SR 124g/h) |
| Supply gas | GPL 28-30 mbar |
| Safety device | Thermocouple |
| Material | Aisi304 Stainless Steel |
| Weight | 2,1 Kg |

 PACKAGE DIMENSION
400X370X240 mm

 PACKAGE WEIGHT
3 Kg

 PACKAGES FOR PALLET
54 (120X120X170) 180 Kg

| PRODUCT | | | FEATURES / SPECIFICATIONS / ACCESSORIES | | | |
|---------|----------|---------|--|---|-------------------------------------|---------------|
| MODEL | IGNITION | VERSION |  12V ELECTRONIC IGNITION |  600025 RUBBER SEAL | SINGLE PACKAGING | ART. NUMBER |
| FC1345 | E | W | <input checked="" type="checkbox"/> | <input type="checkbox"/> | <input type="checkbox"/> | FC1345-E-W |
| FC1345 | E | GR-W | <input checked="" type="checkbox"/> | <input checked="" type="checkbox"/> | <input checked="" type="checkbox"/> | FC1345-E-GR-W |

S MANUAL LIGHTING | **P** PIEZOMECHANIC IGNITION | **E** 12V ELECTRONIC IGNITION



DOWNLOAD
MANUAL
INSTRUCTIONS





FC1348

Elliptic gas hob-unit N°2 burners A-SR.

Oval built-in stove, made from stainless steel, 2-burner gas supply equipped with self-locking lid, stainless steel support grid fixed with anti-vibration rubber pads. Tempered black glass lid with concealed hinges.

| | |
|--------------------|-------------------------|
| Numbers of burners | 2 |
| Dimension | 510x390 mm |
| Power | A 1 kW / SR 1.7 kW |
| Energy Consumption | (A 73g/h) (SR 124g/h) |
| Supply gas | GPL 28-30 mbar |
| Safety device | Thermocouple |
| Material | Aisi304 Stainless Steel |
| Weight | 3,8 Kg |

 PACKAGE DIMENSION
580X400X250 mm

 PACKAGE WEIGHT
5 Kg

 PACKAGES FOR PALLET
36 (100X100X190) 190 Kg

| PRODUCT | | | FEATURES / SPECIFICATIONS / ACCESSORIES | | | |
|---------|----------|---------|--|---|-------------------------------------|---------------|
| MODEL | IGNITION | VERSION |  12V ELECTRONIC IGNITION |  600025 RUBBER SEAL | SINGLE PACKAGING | ART. NUMBER |
| FC1348 | E | W | <input checked="" type="checkbox"/> | <input type="checkbox"/> | <input type="checkbox"/> | FC1348-E-W |
| FC1348 | E | GR-W | <input checked="" type="checkbox"/> | <input checked="" type="checkbox"/> | <input checked="" type="checkbox"/> | FC1348-E-GR-W |

S MANUAL LIGHTING | **P** PIEZOMECHANIC IGNITION | **E** 12V ELECTRONIC IGNITION



DOWNLOAD
MANUAL
INSTRUCTIONS





FC1336

Rectangular gas hob-unit N°2 burners A-SR.



Rectangular built-in stove, made from stainless steel, 2-burner gas supply, stainless steel support grid fixed with anti-vibration grommets. Tempered black glass lid with concealed hinges.

| | |
|--------------------|-------------------------|
| Numbers of burners | 2 |
| Dimension | 530x340 mm |
| Power | A 1 kW / SR 1.7 kW |
| Energy Consumption | (A 73g/h) (SR 124g/h) |
| Supply gas | GPL 28-30 mbar |
| Safety device | Thermocouple |
| Material | Aisi304 Stainless Steel |
| Product Weight | 4,8 Kg |

 PACKAGE DIMENSION
600X400X230 mm

 PACKAGE WEIGHT
6 Kg

 PACKAGES FOR PALLET
36 (100X100X200) 226 Kg

| PRODUCT | | | FEATURES / SPECIFICATIONS / ACCESSORIES | | | | |
|---------|----------|---------|--|--|---|------------------|---------------|
| MODEL | IGNITION | VERSION |  PIEZO MECHANIC IGNITION |  12V ELECTRONIC IGNITION |  600025 RUBBER SEAL | SINGLE PACKAGING | ART. NUMBER |
| FC1336 | P | W | ● | — | — | — | FC1336-P-W |
| FC1336 | P | GR-W | ● | — | ● | ● | FC1336-P-GR-W |
| FC1336 | E | W | — | ● | — | — | FC1336-E-W |
| FC1336 | E | GR-W | — | ● | ● | ● | FC1336-E-GR-W |

S MANUAL LIGHTING | P PIEZOMECHANIC IGNITION | E 12V ELECTRONIC IGNITION



DOWNLOAD
MANUAL
INSTRUCTIONS





FC1346

Built-in rectangular gas hob-unit N°2 burners A-SR.



Compact built-in rectangular cooktop with 2 burners and glass lid. Modular spaces: thanks to the glass cover it is possible to extend the kitchen worktop.

| | |
|--------------------|-------------------------|
| Numbers of burners | 2 |
| Dimension | 460x335x90 mm |
| Power | A 1 kW / SR 1.7 kW |
| Energy Consumption | (A 73g/h) (SR 124g/h) |
| Supply gas | GPL 28-30 mbar |
| Safety device | Thermocouple |
| Material | Aisi304 Stainless Steel |
| Weight | 4,5 Kg |

 PACKAGE DIMENSION
600X400X230 mm

 PACKAGE WEIGHT
6 Kg

 PACKAGES FOR PALLET
36 (100X100X200) 226 Kg

| PRODUCT | | | FEATURES / SPECIFICATIONS / ACCESSORIES | | | | |
|---------|----------|---------|--|--|---|------------------|---------------|
| MODEL | IGNITION | VERSION |  PIEZO MECHANIC IGNITION |  12V ELECTRONIC IGNITION |  600025 RUBBER SEAL | SINGLE PACKAGING | ART. NUMBER |
| FC1346 | P | W | ● | — | — | — | FC1346-P-W |
| FC1346 | P | GR-W | ● | — | ● | ● | FC1346-P-GR-W |
| FC1346 | E | W | — | ● | — | — | FC1346-E-W |
| FC1346 | E | GR-W | — | ● | ● | ● | FC1346-E-GR-W |

S MANUAL LIGHTING | P PIEZOMECHANIC IGNITION | E 12V ELECTRONIC IGNITION



DOWNLOAD
MANUAL
INSTRUCTIONS

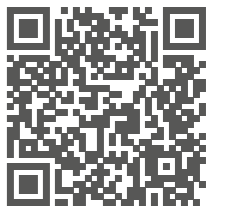



FC1343

Triangular gas hob-unit n°3 burners A-SR-SR.

Left-hand triangle built-in stove, made from stainless steel, 3-burner gas supply, stainless steel support grid fixed with anti-vibration grommets. Tempered black glass lid with concealed hinges.

| | |
|--------------------|--------------------------------------|
| Numbers of burners | 3 |
| Dimension | 480x480 mm |
| Power | A 1 kW / SR 1.7 kW / SR 1.7 kW |
| Energy Consumption | (A 73g/h) (SR 124g/h) (SR 124g/h) |
| Supply gas | GPL 28-30 mbar |
| Safety device | Thermocouple |
| Material | Aisi304 Stainless Steel |
| Product Weight | 5,5 Kg |





PACKAGE DIMENSION
520X520X200 mm



PACKAGE WEIGHT
7 Kg



PACKAGES FOR PALLET
32 (114X114X190) 235 Kg

| PRODUCT | | | FEATURES / SPECIFICATIONS / ACCESSORIES | | | |
|---------|----------|---------|--|---|------------------|---------------|
| MODEL | IGNITION | VERSION |  12V ELECTRONIC IGNITION |  600025 RUBBER SEAL | SINGLE PACKAGING | ART. NUMBER |
| FC1343 | E | W | ● | — | — | FC1343-E-W |
| FC1343 | E | GR-W | ● | ● | ● | FC1343-E-GR-W |

S MANUAL LIGHTING | P PIEZOMECHANIC IGNITION | E 12V ELECTRONIC IGNITION



DOWNLOAD
MANUAL
INSTRUCTIONS



FC1344

Triangular gas hob-unit n°3 burners A-SR-SR.

Right-hand triangle built-in stove, made from stainless steel, 3-burner gas supply, stainless steel support grid fixed with anti-vibration grommets. Tempered black glass lid with concealed hinges.

| | |
|--------------------|--------------------------------------|
| Numbers of burners | 3 |
| Dimension | 480x480 mm |
| Power | A 1 kW / SR 1.7 kW / SR 1.7 kW |
| Energy Consumption | (A 73g/h) (SR 124g/h) (SR 124g/h) |
| Supply gas | GPL 28-30 mbar |
| Safety device | Thermocouple |
| Material | Aisi304 Stainless Steel |
| Weight | 5,5 Kg |





PACKAGE DIMENSION
520X520X200 mm



PACKAGE WEIGHT
7 Kg



PACKAGES FOR PALLET
32 (114X114X190) 235 Kg

| PRODUCT | | | FEATURES / SPECIFICATIONS / ACCESSORIES | | | |
|---------|----------|---------|--|---|------------------|---------------|
| MODEL | IGNITION | VERSION |  12V ELECTRONIC IGNITION |  600025 RUBBER SEAL | SINGLE PACKAGING | ART. NUMBER |
| FC1344 | E | W | ● | — | — | FC1344-E-W |
| FC1344 | E | GR-W | ● | ● | ● | FC1344-E-GR-W |

S MANUAL LIGHTING | P PIEZOMECHANIC IGNITION | E 12V ELECTRONIC IGNITION



DOWNLOAD
MANUAL
INSTRUCTIONS

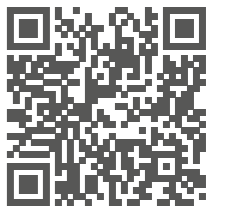



FC1347

Built-in square gas hob-unit N°3 burners A-SR.

Stylish built-in squared cooktop with 3 burners and glass lid. Modular spaces: thanks to the glass cover it is possible to extend the kitchen worktop

| | |
|--------------------|-----------------------------------|
| Numbers of burners | 3 |
| Dimension | 450x450x90 mm |
| Power | A 1 kW / SR 1.7 kW / SR 1.7 kW |
| Energy Consumption | (A 73g/h) (SR 124g/h) (SR 124g/h) |
| Supply gas | GPL 28-30 mbar |
| Safety device | Thermocouple |
| Material | Aisi304 Stainless Steel |
| Weight | 4,0 Kg |





PACKAGE DIMENSION
520X520X200 mm



PACKAGE WEIGHT
6 Kg



PACKAGES FOR PALLET
32 (114X114X190) 210 Kg

| PRODUCT | | | FEATURES / SPECIFICATIONS / ACCESSORIES | | | |
|---------|----------|---------|--|---|------------------|---------------|
| MODEL | IGNITION | VERSION |  12V ELECTRONIC IGNITION |  600025 RUBBER SEAL | SINGLE PACKAGING | ART. NUMBER |
| FC1347 | E | W | ● | — | — | FC1347-E-W |
| FC1347 | E | GR-W | ● | ● | ● | FC1347-E-GR-W |

S MANUAL LIGHTING | P PIEZOMECHANIC IGNITION | E 12V ELECTRONIC IGNITION



DOWNLOAD
MANUAL
INSTRUCTIONS



FC1350

Rectangular gas hob-unit N°3 burners A-SR-SR.

Built in rectangular cooktop, made of stainless steel, 3-burner gas supply, stainless steel support grille fixed with anti-vibration rubbers. Single cover in tempered black glass with concealed hinges.

| | |
|--------------------|-----------------------------------|
| Numbers of burners | 3 |
| Dimension | 716x340mm |
| Power | A 1 kW / SR 1.7 kW / SR 1.7 kW |
| Energy Consumption | (A 73g/h) (SR 124g/h) (SR 124g/h) |
| Supply gas | GPL 28-30 mbar |
| Safety device | Thermocouple |
| Material | Aisi304 Stainless Steel |
| Weight | 5,8 Kg |





PACKAGE DIMENSION
800X400X200 mm



PACKAGE WEIGHT
7 Kg



PACKAGES FOR PALLET
40 (120X120X220) 300 Kg

| PRODUCT | | | FEATURES / SPECIFICATIONS / ACCESSORIES | | | |
|---------|----------|---------|--|---|------------------|---------------|
| MODEL | IGNITION | VERSION |  12V ELECTRONIC IGNITION |  600025 RUBBER SEAL | SINGLE PACKAGING | ART. NUMBER |
| FC1350 | E | W | ● | — | — | FC1350-E-W |
| FC1350 | E | GR-W | ● | ● | ● | FC1350-E-GR-W |

S MANUAL LIGHTING | P PIEZOMECHANIC IGNITION | E 12V ELECTRONIC IGNITION



DOWNLOAD
MANUAL
INSTRUCTIONS

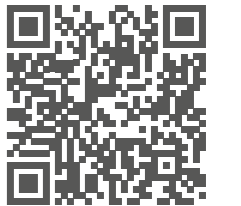



FC1351

Rectangular gas hob-unit N°3 burners A-SR-SR.

Built in rectangular cooktop, made of stainless steel, 3-burner gas supply, stainless steel support grille fixed with anti-vibration rubbers. Single cover in tempered black glass with concealed hinges.

| | |
|--------------------|-----------------------------------|
| Numbers of burners | 3 |
| Dimension | 716x340mm |
| Power | A 1 kW / SR 1.7 kW / SR 1.7 kW |
| Energy Consumption | (A 73g/h) (SR 124g/h) (SR 124g/h) |
| Supply gas | GPL 28-30 mbar |
| Safety device | Thermocouple |
| Material | Aisi304 Stainless Steel |
| Weight | 5,8 Kg |





PACKAGE DIMENSION
800X400X200 mm



PACKAGE WEIGHT
8 Kg



PACKAGES FOR PALLET
40 (120X120X220) 300 Kg

| PRODUCT | | | FEATURES / SPECIFICATIONS / ACCESSORIES | | | |
|---------|----------|---------|--|---|------------------|---------------|
| MODEL | IGNITION | VERSION |  12V ELECTRONIC IGNITION |  600025 RUBBER SEAL | SINGLE PACKAGING | ART. NUMBER |
| FC1351 | E | W | ● | — | — | FC1351-E-W |
| FC1351 | E | GR-W | ● | ● | ● | FC1351-E-GR-W |

S MANUAL LIGHTING | P PIEZOMECHANIC IGNITION | E 12V ELECTRONIC IGNITION



DISCOVER
MORE AT
AIRXCEL.EU



NEW!



FC1362

Gas hob-unit N°2 burners SR.

Built-in stove, made from stainless steel, 2-burner gas supply, stainless steel support grid fixed with anti-vibration grommets. Tempered black glass lid with concealed hinges.

| | |
|--------------------|-------------------------|
| Numbers of burners | 2 |
| Dimension | 640x350 mm |
| Power | SR 1.7 kW / SR 1.7 kW |
| Energy Consumption | (SR 124g/h) (SR 124g/h) |
| Supply gas | GPL 28-30 mbar |
| Safety device | Thermocouple |
| Material | Aisi304 Stainless Steel |
| Weight | 5 Kg |





PACKAGE DIMENSION
800X400X200 mm



PACKAGE WEIGHT
7 Kg



PACKAGES FOR PALLET
40 (120X120X220) 290 Kg

| PRODUCT | | | FEATURES / SPECIFICATIONS / ACCESSORIES | | | |
|---------|----------|---------|--|---|------------------|---------------|
| MODEL | IGNITION | VERSION |  12V ELECTRONIC IGNITION |  600025 RUBBER SEAL | SINGLE PACKAGING | ART. NUMBER |
| FC1362 | E | W | ● | — | — | FC1362-E-W |
| FC1362 | E | GR-W | ● | ● | ● | FC1362-E-GR-W |

S MANUAL LIGHTING | P PIEZOMECHANIC IGNITION | E 12V ELECTRONIC IGNITION



DISCOVER
MORE AT
AIRXCEL.EU



NEW!



FC1363

Gas hob-unit N°3 burners A-SR-SR.

Built-in stove, made from stainless steel, 3-burner gas supply, stainless steel support grid fixed with anti-vibration grommets. Tempered black glass lid with concealed hinges.

| | |
|--------------------|--------------------------------------|
| Numbers of burners | 3 |
| Dimension | 640x350 mm |
| Power | A 1 kW / SR 1.7 kW / SR 1.7 kW |
| Energy Consumption | (A 73g/h) (SR 124g/h) (SR 124g/h) |
| Supply gas | GPL 28-30 mbar |
| Safety device | Thermocouple |
| Material | Aisi304 Stainless Steel |
| Weight | 6 Kg |





PACKAGE DIMENSION
800X400X200 mm



PACKAGE WEIGHT
8 Kg



PACKAGES FOR PALLET
40 (120X120X220) 330 Kg

| PRODUCT | | | FEATURES / SPECIFICATIONS / ACCESSORIES | | | |
|---------|----------|---------|--|---|------------------|---------------|
| MODEL | IGNITION | VERSION |  12V ELECTRONIC IGNITION |  600025 RUBBER SEAL | SINGLE PACKAGING | ART. NUMBER |
| FC1363 | E | W | ● | — | — | FC1363-E-W |
| FC1363 | E | GR-W | ● | ● | ● | FC1363-E-GR-W |

S MANUAL LIGHTING | P PIEZOMECHANIC IGNITION | E 12V ELECTRONIC IGNITION



DISCOVER
MORE AT
AIRXCEL.EU



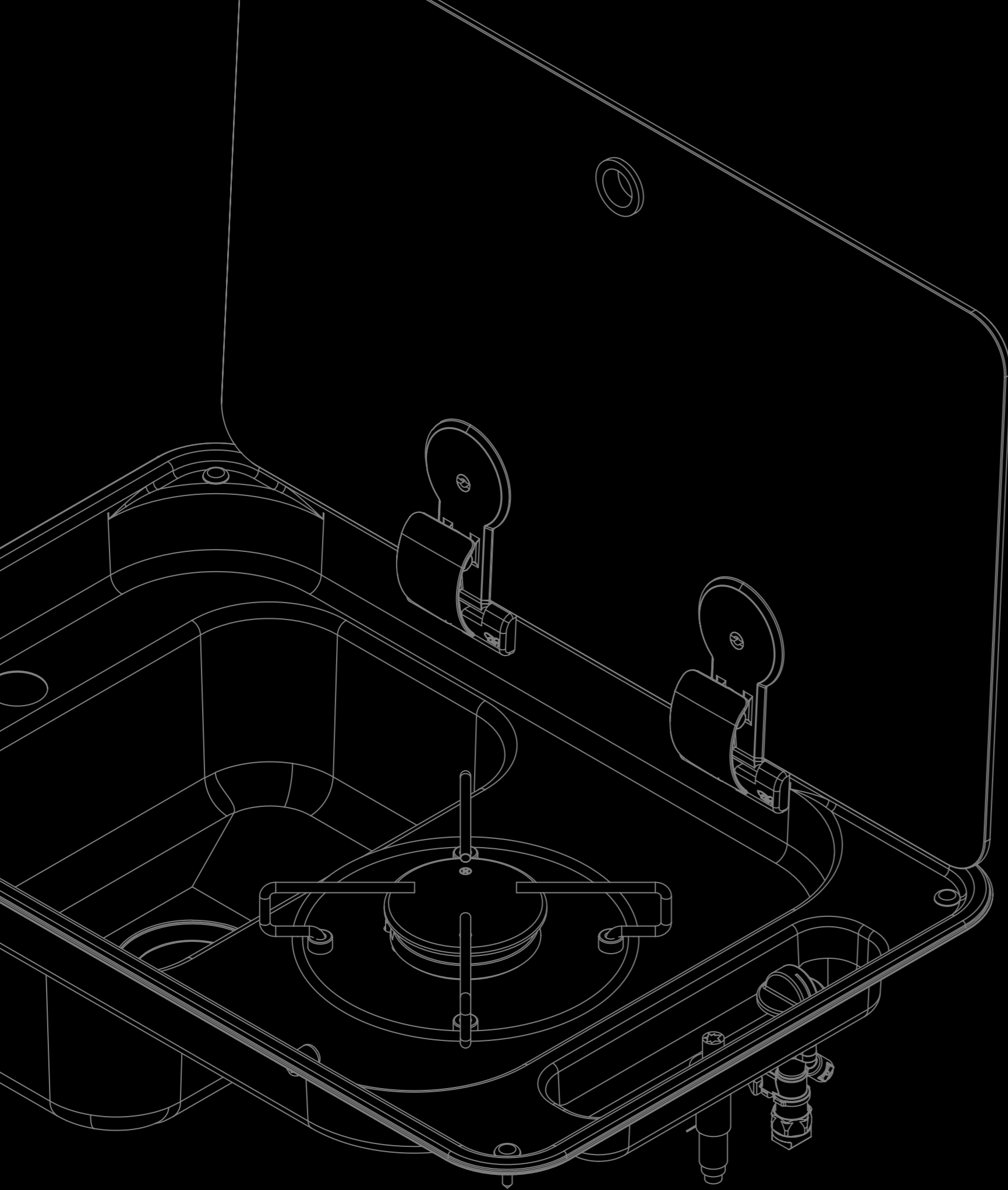

RANDI COMBINATION UNIT

Quality, compactness and functionality, combined with the most flexible design

Monobloc, compact, combined. In the world of travel maximum functionality needs to be achieved, and Randi, the proposed unit-kitchen line, is the range that offers this. Hobs and sink are as one single unit, hidden beneath 4 mm of tempered glass, also creating a practical table top. The design is, as always, customisable: available in the right-hand or left-hand version and with taps and fittings at choice. The pan supports are removable with rubber anti-vibration inserts.

| | | | |
|--------|----|---------|----|
| FL1323 | 46 | FL1765 | 52 |
| FL1324 | 47 | FL1766 | 53 |
| FL1500 | 48 | FL1770 | 54 |
| FL1501 | 49 | FL1780 | 55 |
| FL1502 | 50 | FL1922L | 56 |
| FL1510 | 51 | FL1922R | 57 |



FL1323

The smallest built-in rectangular gas hob-unit ever built - N°1 burners SR with rectangular sink right-handed.

Rectangular built-in stove, made from stainless steel, 1-burner gas supply, equipped with right-hand rectangular sink, stainless steel support grid fixed with anti-vibration grommets. Tempered black glass lid with concealed hinges.

| | |
|--------------------|----------------|
| Numbers of burners | 1 |
| Dimension | 530x340x150 mm |
| Power | SR 1.7 kW |
| Energy Consumption | (SR 124g/h) |
| Supply gas | GPL 28-30 mbar |
| Safety device | Thermocouple |
| Dimension hole tap | ø 27 mm |
| Weight | 4,5 Kg |



PACKAGE DIMENSION
580X400X250 mm



PACKAGE WEIGHT
6 Kg



PACKAGES FOR PALLET
36 (100X100X190) 230 Kg



FL1324

The smallest built-in rectangular gas hob-unit ever built - N°1 burners SR with rectangular sink left-handed.

Rectangular built-in stove, made from stainless steel, 1-burner gas supply, equipped with left-hand rectangular sink, stainless steel support grid fixed with anti-vibration grommets. Tempered black glass lid with concealed hinges.

| | |
|--------------------|----------------|
| Numbers of burners | 1 |
| Dimension | 530x340x150 mm |
| Power | SR 1.7 kW |
| Energy Consumption | (SR 124g/h) |
| Supply gas | GPL 28-30 mbar |
| Safety device | Thermocouple |
| Dimension hole tap | 27 mm |
| Weight | 4,5 Kg |



PACKAGE DIMENSION
580X400X250 mm



PACKAGE WEIGHT
6 Kg



PACKAGES FOR PALLET
36 (100X100X190) 230 Kg

| PRODUCT | | | FEATURES / SPECIFICATIONS / ACCESSORIES | | | | | | |
|---------|----------|---------|--|---|---|--|---|------------------|---------------|
| MODEL | IGNITION | VERSION |  PIEZO MECHANIC IGNITION |  600025 RUBBER SEAL |  WASTE LP1800 |  RB1487 COLD WATER |  RB1488 HOT AND COLD WATER | SINGLE PACKAGING | ART. NUMBER |
| FL1323 | P | W | ● | — | — | — | — | — | FL1323-P-W |
| FL1323 | P | GR-W | ● | ● | ● | — | — | ● | FL1323-P-GR-W |
| FL1323 | P | AF-W | ● | ● | ● | ● | — | ● | FL1323-P-AF-W |
| FL1323 | P | AC-W | ● | ● | ● | — | ● | ● | FL1323-P-AC-W |

S MANUAL LIGHTING | P PIEZOMECHANIC IGNITION | E 12V ELECTRONIC IGNITION



DOWNLOAD
MANUAL
INSTRUCTIONS



| PRODUCT | | | FEATURES / SPECIFICATIONS / ACCESSORIES | | | | | | |
|---------|----------|---------|--|---|---|--|--|------------------|---------------|
| MODEL | IGNITION | VERSION |  PIEZO MECHANIC IGNITION |  600025 RUBBER SEAL |  WASTE LP1800 |  RB1487 COLD WATER |  RB1488 HOT AND COLD WATER | SINGLE PACKAGING | ART. NUMBER |
| FL1324 | P | W | ● | — | — | — | — | — | FL1324-P-W |
| FL1324 | P | GR-W | ● | ● | ● | — | — | ● | FL1324-P-GR-W |
| FL1324 | P | AF-W | ● | ● | ● | ● | — | ● | FL1324-P-AF-W |
| FL1324 | P | AC-W | ● | ● | ● | — | ● | ● | FL1324-P-AC-W |

S MANUAL LIGHTING | P PIEZOMECHANIC IGNITION | E 12V ELECTRONIC IGNITION



DOWNLOAD
MANUAL
INSTRUCTIONS





FL1500

The most compact built-in rectangular gas hob-unit - N°2 burners A-SR Rectangular sink right-handed.

Rectangular built-in stove, made from stainless steel, 2-burner gas supply, equipped with right-hand rectangular sink, stainless steel support grid fixed with anti-vibration grommets. Single lid in black tempered glass with concealed hinges.

| | |
|--------------------|-----------------------|
| Numbers of burners | 2 |
| Dimension | 716x340x150 mm |
| Power | A 1 kW / SR 1.7 kW |
| Energy Consumption | (A 73g/h) (SR 124g/h) |
| Supply gas | GPL 28-30 mbar |
| Safety device | Thermocouple |
| Dimension hole tap | ø 27 mm |
| Weight | 5 Kg |



PACKAGE DIMENSION
800X400X200 mm



PACKAGE WEIGHT
7 Kg



PACKAGES FOR PALLET
40 (120X120X220) 300 Kg



FL1501

The most compact built-in rectangular gas hob-unit - N°2 burners A-SR Rectangular sink right-handed.

Made from stainless steel, 2-burner gas supply, equipped with right-hand rectangular sink, stainless steel support grid fixed with anti-vibration grommets. Double lid in tempered black glass, divided between cooking area and sink, with concealed hinges.

| | |
|--------------------|-----------------------|
| Numbers of burners | 2 |
| Dimension | 716x340x150 mm |
| Power | A 1 kW / SR 1.7 kW |
| Energy Consumption | (A 73g/h) (SR 124g/h) |
| Supply gas | GPL 28-30 mbar |
| Safety device | Thermocouple |
| Dimension hole tap | ø 27 mm |
| Weight | 5 Kg |



PACKAGE DIMENSION
800X400X200 mm



PACKAGE WEIGHT
7 Kg



PACKAGES FOR PALLET
40 (120X120X220) 300 Kg

| PRODUCT | | | FEATURES / SPECIFICATIONS / ACCESSORIES | | | | | | | |
|---------|----------|---------|---|-------------------------|--------------------|--------------|-------------------|---------------------------|------------------|---------------|
| MODEL | IGNITION | VERSION | PIEZO MECHANIC IGNITION | 12V ELECTRONIC IGNITION | 600025 RUBBER SEAL | WASTE LP1800 | RB1487 COLD WATER | RB1488 HOT AND COLD WATER | SINGLE PACKAGING | ART. NUMBER |
| FL1500 | E | W | — | ● | — | — | — | — | — | FL1500-E-W |
| FL1500 | E | GR-W | — | ● | ● | ● | — | — | ● | FL1500-E-GR-W |
| FL1500 | P | W | ● | — | — | — | — | — | — | FL1500-P-W |
| FL1500 | P | GR-W | ● | — | ● | ● | — | — | ● | FL1500-P-GR-W |
| FL1500 | P | AF-W | ● | — | ● | ● | ● | — | ● | FL1500-P-AF-W |
| FL1500 | P | AC-W | ● | — | ● | ● | — | ● | ● | FL1500-P-AC-W |

S MANUAL LIGHTING | P PIEZOMECHANIC IGNITION | E 12V ELECTRONIC IGNITION



DOWNLOAD
MANUAL
INSTRUCTIONS



| PRODUCT | | | FEATURES / SPECIFICATIONS / ACCESSORIES | | | | | | | |
|---------|----------|---------|---|-------------------------|--------------------|--------------|-------------------|---------------------------|------------------|---------------|
| MODEL | IGNITION | VERSION | PIEZO MECHANIC IGNITION | 12V ELECTRONIC IGNITION | 600025 RUBBER SEAL | WASTE LP1800 | RB1487 COLD WATER | RB1488 HOT AND COLD WATER | SINGLE PACKAGING | ART. NUMBER |
| FL1501 | E | W | — | ● | — | — | — | — | — | FL1501-E-W |
| FL1501 | E | GR-W | — | ● | ● | ● | — | — | ● | FL1501-E-GR-W |
| FL1501 | P | W | ● | — | — | — | — | — | — | FL1501-P-W |
| FL1501 | P | GR-W | ● | — | ● | ● | — | — | ● | FL1501-P-GR-W |
| FL1501 | P | AF-W | ● | — | ● | ● | ● | — | ● | FL1501-P-AF-W |
| FL1501 | P | AC-W | ● | — | ● | ● | — | ● | ● | FL1501-P-AC-W |

S MANUAL LIGHTING | P PIEZOMECHANIC IGNITION | E 12V ELECTRONIC IGNITION



DOWNLOAD
MANUAL
INSTRUCTIONS



FL1502

The most compact built-in rectangular gas hob-unit - N°2 burners A-SR Rectangular sink left-handed.

Made from stainless steel, 2-burner gas supply, equipped with left-hand rectangular sink, stainless steel support grid fixed with anti-vibration grommets. Double lid in tempered black glass, divided between cooking area and sink, with concealed hinges.

| | |
|--------------------|-----------------------|
| Numbers of burners | 2 |
| Dimension | 716x340x150 mm |
| Power | A 1 kW / SR 1.7 kW |
| Energy Consumption | (A 73g/h) (SR 124g/h) |
| Supply gas | GPL 28-30 mbar |
| Safety device | Thermocouple |
| Dimension hole tap | ø 27 mm |
| Weight | 6 Kg |



PACKAGE DIMENSION
800X400X200 mm



PACKAGE WEIGHT
7 Kg



PACKAGES FOR PALLET
40 (120X120X220) 300 Kg

| PRODUCT | | | FEATURES / SPECIFICATIONS / ACCESSORIES | | | | | | | |
|---------|----------|---------|---|-------------------------|--------------------|--------------|-------------------|---------------------------|------------------|---------------|
| MODEL | IGNITION | VERSION | PIEZO MECHANIC IGNITION | 12V ELECTRONIC IGNITION | 600025 RUBBER SEAL | WASTE LP1800 | RB1487 COLD WATER | RB1488 HOT AND COLD WATER | SINGLE PACKAGING | ART. NUMBER |
| FL1502 | E | W | — | ● | — | — | — | — | — | FL1502-E-W |
| FL1502 | E | GR-W | — | ● | ● | ● | — | — | ● | FL1502-E-GR-W |
| FL1502 | P | W | ● | — | — | — | — | — | — | FL1502-P-W |
| FL1502 | P | GR-W | ● | — | ● | ● | — | — | ● | FL1502-P-GR-W |
| FL1502 | P | AF-W | ● | — | ● | ● | ● | — | ● | FL1502-P-AF-W |
| FL1502 | P | AC-W | ● | — | ● | ● | — | ● | ● | FL1502-P-AC-W |

S MANUAL LIGHTING | P PIEZOMECHANIC IGNITION | E 12V ELECTRONIC IGNITION



DOWNLOAD
MANUAL
INSTRUCTIONS



FL1510

The most compact built-in rectangular gas hob-unit - N°2 burners A-SR Rectangular sink left-handed.

Made from stainless steel, 2-burner gas supply, equipped with left-hand rectangular sink, stainless steel support grid fixed with anti-vibration grommets. Single lid in black tempered glass with concealed hinges.

| | |
|--------------------|-----------------------|
| Numbers of burners | 2 |
| Dimension | 716x340x150 mm |
| Power | A 1 kW / SR 1.7 kW |
| Energy Consumption | (A 73g/h) (SR 124g/h) |
| Supply gas | GPL 28-30 mbar |
| Safety device | Thermocouple |
| Dimension hole tap | ø 27 mm |
| Weight | 7 Kg |



PACKAGE DIMENSION
800X400X200 mm



PACKAGE WEIGHT
7 Kg



PACKAGES FOR PALLET
40 (120X120X220) 300 Kg

| PRODUCT | | | FEATURES / SPECIFICATIONS / ACCESSORIES | | | | | | | |
|---------|----------|---------|---|-------------------------|--------------------|--------------|-------------------|---------------------------|------------------|---------------|
| MODEL | IGNITION | VERSION | PIEZO MECHANIC IGNITION | 12V ELECTRONIC IGNITION | 600025 RUBBER SEAL | WASTE LP1800 | RB1487 COLD WATER | RB1488 HOT AND COLD WATER | SINGLE PACKAGING | ART. NUMBER |
| FL1510 | E | W | — | ● | — | — | — | — | — | FL1510-E-W |
| FL1510 | E | GR-W | — | ● | ● | ● | — | — | ● | FL1510-E-GR-W |
| FL1510 | P | W | ● | — | — | — | — | — | — | FL1510-P-W |
| FL1510 | P | GR-W | ● | — | ● | ● | — | — | ● | FL1510-P-GR-W |
| FL1510 | P | AF-W | ● | — | ● | ● | ● | — | ● | FL1510-P-AF-W |
| FL1510 | P | AC-W | ● | — | ● | ● | — | ● | ● | FL1510-P-AC-W |

S MANUAL LIGHTING | P PIEZOMECHANIC IGNITION | E 12V ELECTRONIC IGNITION



DOWNLOAD
MANUAL
INSTRUCTIONS





FL1765

Rectangular gas hob-unit N°2 burners A-SR with rectangular sink right-hand, tap and waste not included.

Made from stainless steel, 2-burner gas supply, equipped with right-hand rectangular sink, stainless steel support grid fixed with anti-vibration grommets. Double lid in tempered black glass, divided between cooking area and sink, with concealed hinges.

| | |
|--------------------|-----------------------|
| Numbers of burners | 2 |
| Dimension | 765x355x100+50 mm |
| Power | A 1 kW / SR 1.7 kW |
| Energy Consumption | (A 73g/h) (SR 124g/h) |
| Supply gas | GPL 28-30 mbar |
| Safety device | Thermocouple |
| Dimension hole tap | ø 33 mm |
| Weight | 6 Kg |



PACKAGE DIMENSION
800X400X200 mm



PACKAGE WEIGHT
7 Kg



PACKAGES FOR PALLET
40 (120X120X220) 300 Kg



FL1766

Rectangular gas hob-unit N°2 burners A-SR with rectangular sink left-hand, tap and waste not included.

Made from stainless steel, 2-burner gas supply, equipped with left-hand rectangular sink, stainless steel support grid fixed with anti-vibration grommets. Double lid in tempered black glass, divided between cooking area and sink, with concealed hinges.

| | |
|--------------------|-----------------------|
| Numbers of burners | 2 |
| Dimension | 765x355x100+50 mm |
| Power | A 1 kW / SR 1.7 kW |
| Energy Consumption | (A 73g/h) (SR 124g/h) |
| Supply gas | GPL 28-30 mbar |
| Safety device | Thermocouple |
| Dimension hole tap | ø 33 mm |
| Weight | 6 Kg |









PACKAGE DIMENSION
800X400X200 mm









PACKAGE WEIGHT
7 Kg



PACKAGES FOR PALLET
40 (120X120X220) 300 Kg

| PRODUCT | | | FEATURES / SPECIFICATIONS / ACCESSORIES | | | | | | | |
|---------|----------|---------|---|---|--|--|---|---|-----------------|---------------|
| MODEL | IGNITION | VERSION |  PIEZO MECHANIC IGNITION |  12V ELECTRONIC IGNITION |  600025 RUBBER SEAL |  WASTE LP1800 |  RB1487 COLD WATER |  RB1488 HOT AND COLD WATER | SINGLE PACKGING | ART. NUMBER |
| FL1765 | P | W | ● | — | — | — | — | — | — | FL1765-P-W |
| FL1765 | P | GR-W | ● | — | ● | ● | — | — | ● | FL1765-P-GR-W |
| FL1765 | E | W | — | ● | — | — | — | — | — | FL1765-E-W |
| FL1765 | E | GR-W | — | ● | ● | ● | ● | — | ● | FL1765-E-GR-W |
| FL1765 | P | AF-W | ● | — | ● | ● | ● | — | ● | FL1765-P-AF-W |
| FL1765 | P | AC-W | ● | — | ● | ● | — | ● | ● | FL1765-P-AC-W |

S MANUAL LIGHTING | P PIEZOMECHANIC IGNITION | E 12V ELECTRONIC IGNITION

| PRODUCT | | | FEATURES / SPECIFICATIONS / ACCESSORIES | | | | | | | |
|---------|----------|---------|---|---|--|--|---|---|-----------------|---------------|
| MODEL | IGNITION | VERSION |  PIEZO MECHANIC IGNITION |  12V ELECTRONIC IGNITION |  600025 RUBBER SEAL |  WASTE LP1800 |  RB1487 COLD WATER |  RB1488 HOT AND COLD WATER | SINGLE PACKGING | ART. NUMBER |
| FL1766 | P | W | ● | — | — | — | — | — | — | FL1766-P-W |
| FL1766 | P | GR-W | ● | — | ● | ● | — | — | ● | FL1766-P-GR-W |
| FL1766 | E | W | — | ● | — | — | — | — | — | FL1766-E-W |
| FL1766 | E | GR-W | — | ● | ● | ● | ● | — | ● | FL1766-E-GR-W |
| FL1766 | P | AF-W | ● | — | ● | ● | ● | — | ● | FL1766-P-AF-W |
| FL1766 | P | AC-W | ● | — | ● | ● | — | ● | ● | FL1766-P-AC-W |

S MANUAL LIGHTING | P PIEZOMECHANIC IGNITION | E 12V ELECTRONIC IGNITION



DOWNLOAD
MANUAL
INSTRUCTIONS



DOWNLOAD
MANUAL
INSTRUCTIONS





FL1770

Rectangular gas hob-unit N°2 burners A-SR with rectangular sink right-hand, tap and waste not included.

Made from stainless steel, 2-burner gas supply, equipped with right-hand rectangular sink, stainless steel support grid fixed with anti-vibration grommets. Tempered black glass lid with concealed hinges.

| | |
|--------------------|-----------------------|
| Numbers of burners | 2 |
| Dimension | 765x355x100+50 mm |
| Power | A 1 kW / SR 1.7 kW |
| Energy Consumption | (A 73g/h) (SR 124g/h) |
| Supply gas | GPL 28-30 mbar |
| Safety device | Thermocouple |
| Dimension hole tap | ø 33 mm |
| Weight | 6 Kg |



PACKAGE DIMENSION
800X400X200 mm



PACKAGE WEIGHT
7 Kg



PACKAGES FOR PALLET
40 (120X120X220) 300 Kg



FL1780

Rectangular gas hob-unit N°2 burners A-SR with rectangular sink left-hand, tap and waste not included.

Made from stainless steel, 2-burner gas supply, equipped with left-hand rectangular sink, stainless steel support grid fixed with anti-vibration grommets. Tempered black glass lid with concealed hinges.

| | |
|--------------------|-----------------------|
| Numbers of burners | 2 |
| Dimension | 765x355x100+50 mm |
| Power | A 1 kW / SR 1.7 kW |
| Energy Consumption | (A 73g/h) (SR 124g/h) |
| Supply gas | GPL 28-30 mbar |
| Safety device | Thermocouple |
| Dimension hole tap | ø 33 mm |
| Weight | 6 Kg |



PACKAGE DIMENSION
800X400X200 mm



PACKAGE WEIGHT
7 Kg



PACKAGES FOR PALLET
40 (120X120X220) 300 Kg

| PRODUCT | | | FEATURES / SPECIFICATIONS / ACCESSORIES | | | | | | | |
|---------|----------|---------|---|-------------------------|--------------------|--------------|-------------------|---------------------------|-----------------|---------------|
| MODEL | IGNITION | VERSION | PIEZO MECHANIC IGNITION | 12V ELECTRONIC IGNITION | 600025 RUBBER SEAL | WASTE LP1800 | RB1487 COLD WATER | RB1488 HOT AND COLD WATER | SINGLE PACKGING | ART. NUMBER |
| FL1770 | P | W | ● | — | — | — | — | — | — | FL1770-P-W |
| FL1770 | P | GR-W | ● | — | ● | ● | — | — | ● | FL1770-P-GR-W |
| FL1770 | E | W | — | ● | — | — | — | — | — | FL1770-E-W |
| FL1770 | E | GR-W | — | ● | ● | ● | — | — | ● | FL1770-E-GR-W |

S MANUAL LIGHTING | P PIEZOMECHANIC IGNITION | E 12V ELECTRONIC IGNITION

| PRODUCT | | | FEATURES / SPECIFICATIONS / ACCESSORIES | | | | | | | |
|---------|----------|---------|---|-------------------------|--------------------|--------------|-------------------|---------------------------|-----------------|---------------|
| MODEL | IGNITION | VERSION | PIEZO MECHANIC IGNITION | 12V ELECTRONIC IGNITION | 600025 RUBBER SEAL | WASTE LP1800 | RB1487 COLD WATER | RB1488 HOT AND COLD WATER | SINGLE PACKGING | ART. NUMBER |
| FL1780 | P | W | ● | — | — | — | — | — | — | FL1780-P-W |
| FL1780 | P | GR-W | ● | — | ● | ● | — | — | ● | FL1780-P-GR-W |
| FL1780 | E | W | — | ● | — | — | — | — | — | FL1780-E-W |
| FL1780 | E | GR-W | — | ● | ● | ● | — | — | ● | FL1780-E-GR-W |

S MANUAL LIGHTING | P PIEZOMECHANIC IGNITION | E 12V ELECTRONIC IGNITION



DOWNLOAD
MANUAL
INSTRUCTIONS



DOWNLOAD
MANUAL
INSTRUCTIONS



FL1922R-P-W

Rectangular gas hob-unit N°2 burners A-SR with rectangular sink right-hand, tap and waste not included.

Made from stainless steel, 2-burner gas supply, equipped with right-hand rectangular sink, stainless steel support grid fixed with anti-vibration grommets. Tempered black glass lid with concealed hinges.







| | |
|--------------------|-----------------------|
| Numbers of burners | 2 |
| Dimension | 765x325x150 mm |
| Power | A 1 kW / SR 1.7 kW |
| Energy Consumption | (A 73g/h) (SR 124g/h) |
| Supply gas | GPL 28-30 mbar |
| Safety device | Thermocouple |
| Dimension hole tap | ø 33 mm |
| Weight | 6 Kg |



 **PACKAGE DIMENSION**
800X400X200 mm

 **PACKAGE WEIGHT**
7 Kg

 **PACKAGES FOR PALLET**
40 (120X120X220) 300 Kg

| PRODUCT | | | FEATURES / SPECIFICATIONS / ACCESSORIES | | | | | | | |
|---------|----------|---------|--|--|---|---|--|--|-----------------|----------------|
| MODEL | IGNITION | VERSION |  PIEZO MECHANIC IGNITION |  12V ELECTRONIC IGNITION |  600025 RUBBER SEAL |  WASTE LP1800 |  RB1487 COLD WATER |  RB1488 HOT AND COLD WATER | SINGLE PACKGING | ART. NUMBER |
| FL1922R | P | W | ● | — | — | — | — | — | — | FL1922R-P-W |
| FL1922R | P | GR-W | ● | — | ● | ● | — | — | ● | FL1922R-P-GR-W |

S MANUAL LIGHTING | P PIEZOMECHANIC IGNITION | E 12V ELECTRONIC IGNITION



DOWNLOAD
MANUAL
INSTRUCTIONS



FL1922L-P-W

Rectangular gas hob-unit N°2 burners A-SR with rectangular sink left-hand, tap and waste not included.

Made from stainless steel, 2-burner gas supply, equipped with left-hand rectangular sink, stainless steel support grid fixed with anti-vibration grommets. Tempered black glass lid with concealed hinges.

| | |
|--------------------|-----------------------|
| Numbers of burners | 2 |
| Dimension | 765x325x150 mm |
| Power | A 1 kW / SR 1.7 kW |
| Energy Consumption | (A 73g/h) (SR 124g/h) |
| Supply gas | GPL 28-30 mbar |
| Safety device | Thermocouple |
| Dimension hole tap | ø 33 mm |
| Weight | 6 Kg |



 **PACKAGE DIMENSION**
800X400X200 mm

 **PACKAGE WEIGHT**
7 Kg

 **PACKAGES FOR PALLET**
40 (120X120X220) 300 Kg

| PRODUCT | | | FEATURES / SPECIFICATIONS / ACCESSORIES | | | | | | | |
|---------|----------|---------|--|--|---|---|--|--|-----------------|----------------|
| MODEL | IGNITION | VERSION |  PIEZO MECHANIC IGNITION |  12V ELECTRONIC IGNITION |  600025 RUBBER SEAL |  WASTE LP1800 |  RB1487 COLD WATER |  RB1488 HOT AND COLD WATER | SINGLE PACKGING | ART. NUMBER |
| FL1922L | P | W | ● | — | — | — | — | — | — | FL1922L-P-W |
| FL1922L | P | GR-W | ● | — | ● | ● | — | — | ● | FL1922L-P-GR-W |

S MANUAL LIGHTING | P PIEZOMECHANIC IGNITION | E 12V ELECTRONIC IGNITION



DOWNLOAD
MANUAL
INSTRUCTIONS



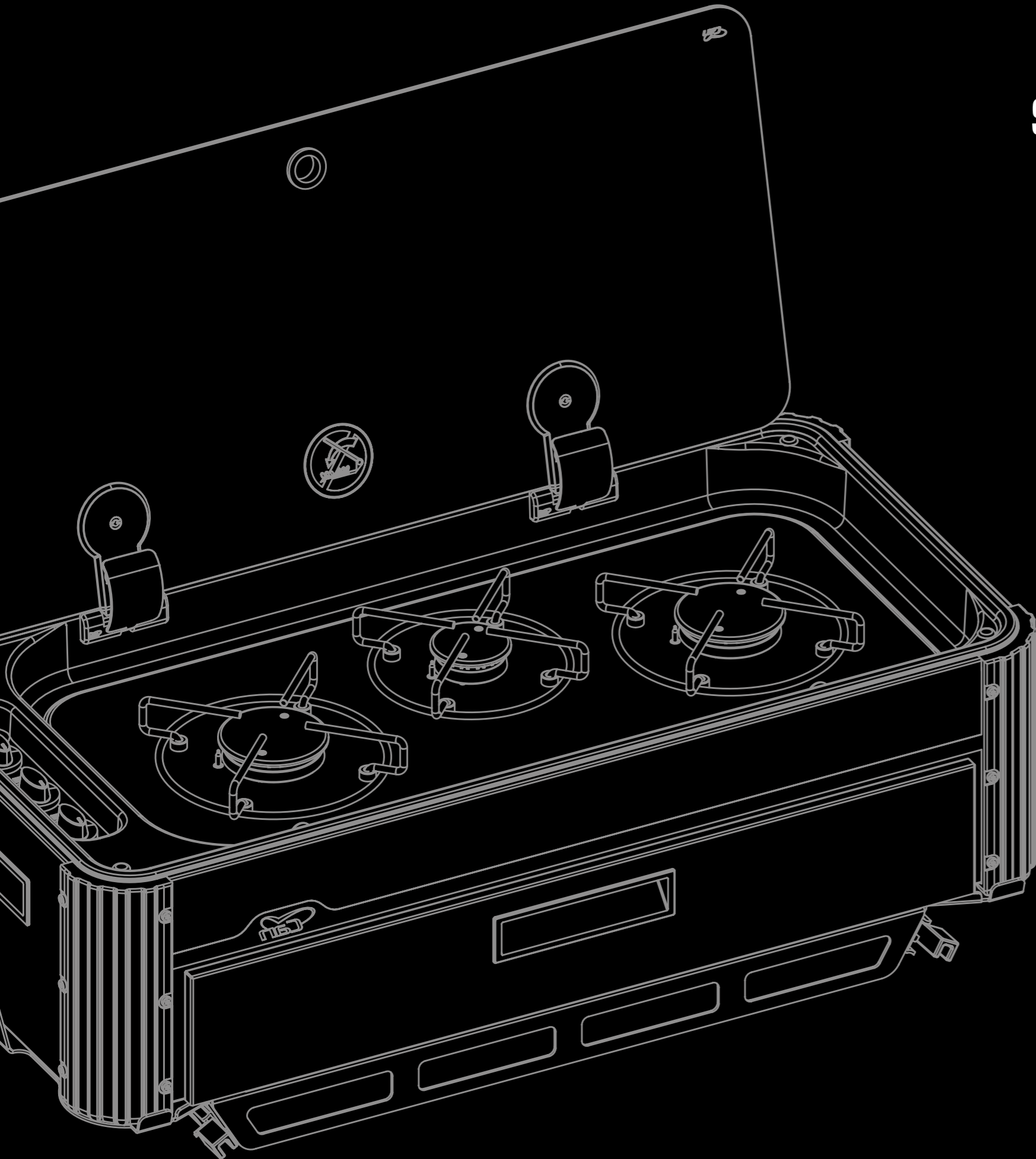

SLIDE OUT PORTABLE KITCHEN

Extractable, removable, manageable and convenient to transport

Quick couplings for water, gas and the supplied guides. Ideal for use in exterior environments. Possibility to create a hidden kitchenette. Telescopic legs for outdoor BBQ style use.

SL1323 60 SL1400 61



SL1323

Extractable sliding out portable outdoor kitchen: combination unit with one burners and sink.

Slide-out portable kitchen equipped by sliding base with extraction from the short side. A unique and versatile appliance for an exciting and immersive outdoor cooking experience

| | |
|---------------------|----------------------|
| Numbers of burners | 1 |
| Dimension SL1323-LC | 686x374x250mm |
| Dimension SL1323-LL | 590x483x250mm |
| Power | SR 1.7 kW |
| Energy Consumption | (SR 124g/h) |
| Supply gas | GPL 28-30mbar |
| Safety device | Thermocouple |
| Height with Legs | min 724mm max 1000mm |
| Weight | 16 Kg |

PACKAGE DIMENSION
800X550X350 mm

PACKAGE WEIGHT
22 Kg

PACKAGES FOR PALLET
12 (114X114X170) 280Kg



SL1400

Extractable sliding out portable outdoor kitchen: combination unit with two burners and sink.

Slide-out portable kitchen equipped by sliding base with extraction from the short side. A unique and versatile appliance for an exciting and immersive outdoor cooking experience

| | |
|---------------------|-----------------------|
| Numbers of burners | 2 |
| Dimension SL1400-LC | 839x347x250mm |
| Dimension SL1400-LL | 765x483x250mm |
| Power | A 1 kW / SR 1.7 kW |
| Energy Consumption | (A 73g/h) (SR 124g/h) |
| Supply gas | GPL 28-30mbar |
| Safety device | Thermocouple |
| Height with Legs | min 724mm max 1000mm |
| Weight | 28 Kg |

PACKAGE DIMENSION
860X435X350 mm

PACKAGE WEIGHT
32 Kg

PACKAGES FOR PALLET
12 (114X114X170) 280Kg

| PRODUCT | | FEATURES / SPECIFICATIONS / ACCESSORIES | | | | | | | |
|---------|----------|---|-------------------------|--------------------|--------------|-------------------|---------------------------|-----------------|-------------|
| MODEL | IGNITION | VERSION | PIEZO MECHANIC IGNITION | 600025 RUBBER SEAL | WASTE LP1800 | RB1487 COLD WATER | RB1488 HOT AND COLD WATER | SINGLE PACKGING | ART. NUMBER |
| SL1323 | P | LC | ● | — | ● | ● | — | ● | SL1323-P-LC |
| SL1323 | P | LL | ● | — | ● | ● | — | ● | SL1323-P-LL |

S MANUAL LIGHTING | P PIEZOMECHANIC IGNITION | E 12V ELECTRONIC IGNITION

| PRODUCT | | FEATURES / SPECIFICATIONS / ACCESSORIES | | | | | | | |
|---------|----------|---|-------------------------|--------------------|--------------|-------------------|---------------------------|-----------------|-------------|
| MODEL | IGNITION | VERSION | PIEZO MECHANIC IGNITION | 600025 RUBBER SEAL | WASTE LP1800 | RB1487 COLD WATER | RB1488 HOT AND COLD WATER | SINGLE PACKGING | ART. NUMBER |
| SL1400 | P | LC | ● | — | ● | ● | — | ● | SL1400-P-LC |
| SL1400 | P | LL | ● | — | ● | ● | — | ● | SL1400-P-LL |

S MANUAL LIGHTING | P PIEZOMECHANIC IGNITION | E 12V ELECTRONIC IGNITION

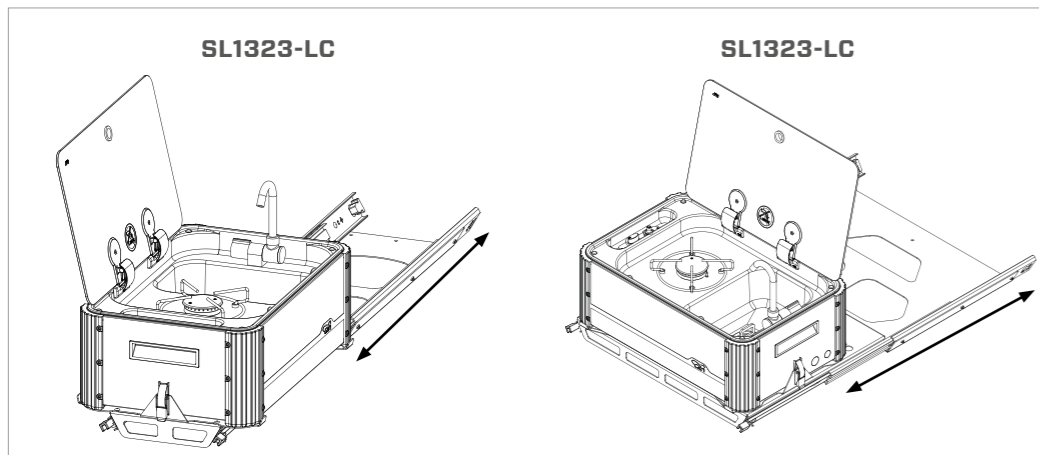

DOWNLOAD
MANUAL
INSTRUCTIONS

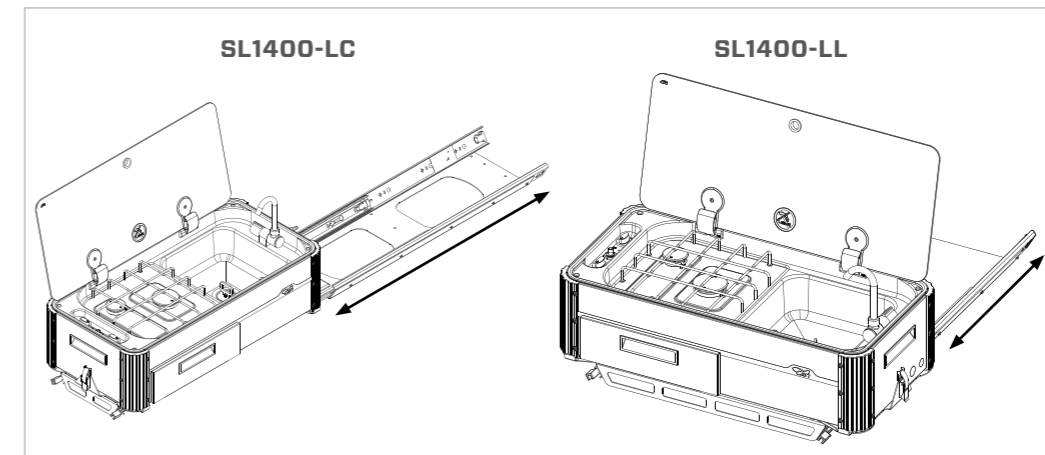

DOWNLOAD
MANUAL
INSTRUCTIONS





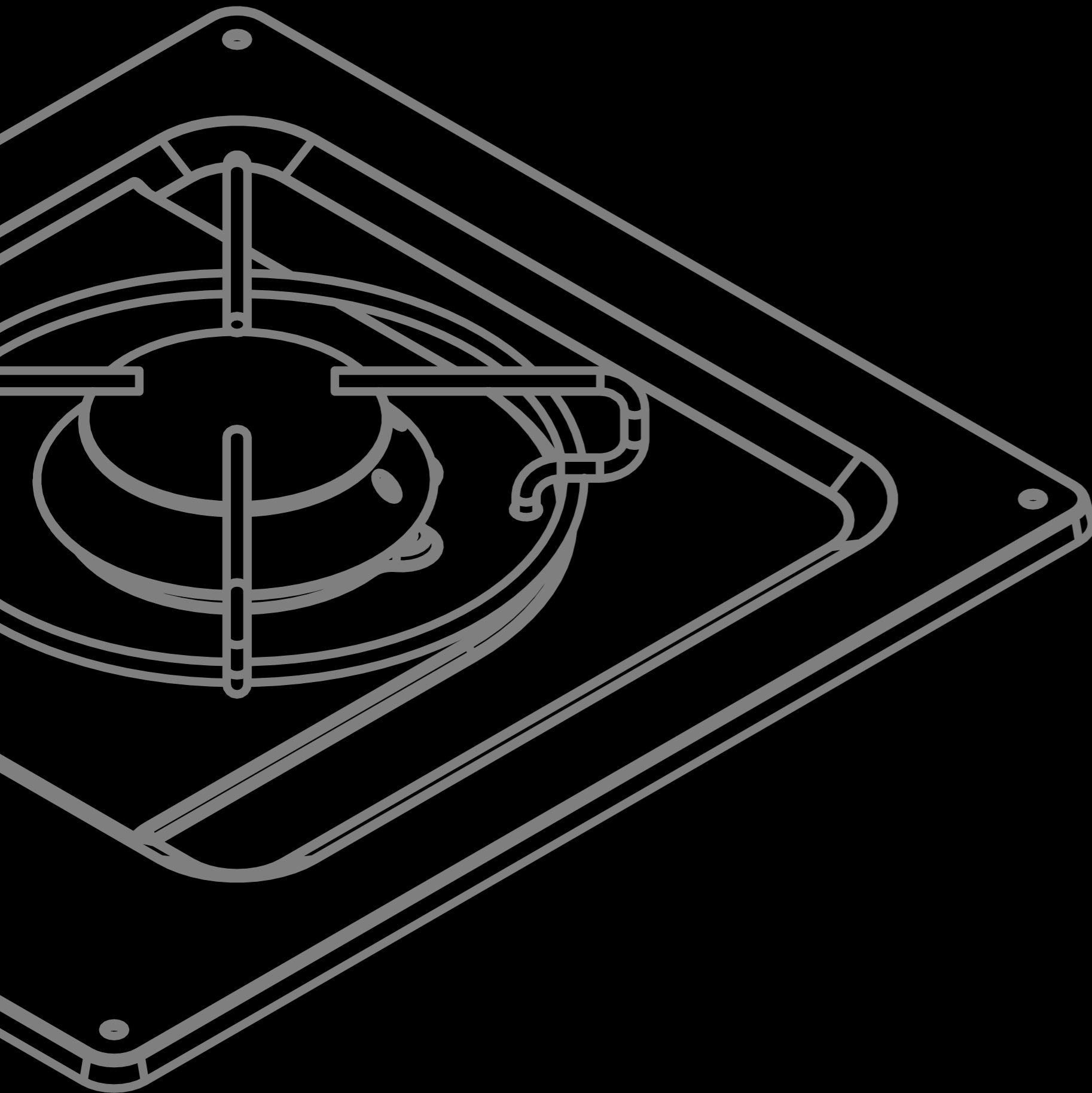

HOTTY

Simple. How to cook.

At times, the more complex requirements have a simple solution. The Hotty: the CAN pressed stainless steel hob line can be installed on any surface with extreme ease, and support almost every request: with 1, 2 or 3 burners the kitchen is always a comfortable space.

PC1320

66

PC1322

68

PC1321

67

PC1323

69

PC1320

Gas hob unit N°1 burner SR.

Built-in hob in mirror polished stainless steel with 1 burner. There is a special sleeve placed on the top of the unit that is used as a seat for the column type pan-holder.



| | |
|--------------------|-------------------------|
| Numbers of burners | 1 |
| Dimension | 285x320 mm |
| Power | SR 1.7 kW |
| Energy Consumption | (SR 124g/h) |
| Supply gas | GPL 28-30 mbar |
| Safety device | Thermocouple |
| Material | Aisi304 Stainless Steel |
| Weight | 2,2 Kg |



PACKAGE DIMENSION
330X400X130 mm



PACKAGE WEIGHT
3 Kg



PACKAGES FOR PALLET
60 (80X120X180) 190 Kg

| PRODUCT | | FEATURES / SPECIFICATIONS / ACCESSORIES | | | |
|---------|----------|---|-----------------|------------------|-------------|
| MODEL | IGNITION | VERSION | MANUAL LIGHTING | SINGLE PACKAGING | ART. NUMBER |
| PC1320 | S | | ● | — | PC1320-S |
| PC1320 | S | GR | ● | ● | PC1320-S-GR |

S MANUAL LIGHTING | P PIEZOMECHANIC IGNITION | E 12V ELECTRONIC IGNITION



DISCOVER
MORE AT
AIRXCEL.EU



PC1321

Gas hob unit N°2 burners SR-SR.

Built-in hob in mirror polished stainless steel with 2 burners. There is a special sleeve placed on the top of the unit that is used as a seat for the column type pan-holder.



| | |
|--------------------|-------------------------|
| Numbers of burners | 2 |
| Dimension | 350x320 mm |
| Power | SR 1.7 kW / SR 1.7 kW |
| Energy Consumption | (SR 124g/h) (SR 124g/h) |
| Supply gas | GPL 28-30 mbar |
| Safety device | Thermocouple |
| Material | Aisi304 Stainless Steel |
| Weight | 2,2 Kg |



PACKAGE DIMENSION
360X330X130 mm



PACKAGE WEIGHT
3,5 Kg



PACKAGES FOR PALLET
60 (80X120X180) 220 Kg

| PRODUCT | | FEATURES / SPECIFICATIONS / ACCESSORIES | | | |
|---------|----------|---|-----------------|------------------|-------------|
| MODEL | IGNITION | VERSION | MANUAL LIGHTING | SINGLE PACKAGING | ART. NUMBER |
| PC1321 | S | | ● | — | PC1321-S |
| PC1321 | S | GR | ● | ● | PC1321-S-GR |

S MANUAL LIGHTING | P PIEZOMECHANIC IGNITION | E 12V ELECTRONIC IGNITION



DISCOVER
MORE AT
AIRXCEL.EU



PC1322

Gas hob unit N°2 burners SR-SR.

Built-in hob in mirror polished stainless steel with 2 burners. There is a special sleeve placed on the top of the unit that is used as a seat for the column type pan-holder.

| | |
|--------------------|-------------------------|
| Numbers of burners | 2 |
| Dimension | 380x360 mm |
| Power | SR 1.7 kW / SR 1.7 kW |
| Energy Consumption | (SR 124g/h) (SR 124g/h) |
| Supply gas | GPL 28-30 mbar |
| Safety device | Thermocouple |
| Material | Aisi304 Stainless Steel |
| Weight | 3,5 Kg |



PACKAGE DIMENSION
560X430X180 mm



PACKAGE WEIGHT
4,5 Kg



PACKAGES FOR PALLET
36 (900X120X120) 180 Kg

| PRODUCT | | FEATURES / SPECIFICATIONS / ACCESSORIES | | | |
|---------|----------|---|-----------------|------------------|-------------|
| MODEL | IGNITION | VERSION | MANUAL LIGHTING | SINGLE PACKAGING | ART. NUMBER |
| PC1322 | S | | ● | — | PC1322-S |
| PC1322 | S | GR | ● | ● | PC1322-S-GR |

S MANUAL LIGHTING | P PIEZOMECHANIC IGNITION | E 12V ELECTRONIC IGNITION



DISCOVER
MORE AT
AIRXCEL.EU



PC1323

Gas hob unit N°3 burners A-SR-R.

Built-in hob in mirror polished stainless steel with 3 burners. There is a special sleeve placed on the top of the unit that is used as a seat for the column type pan-holder.

| | |
|--------------------|----------------------------------|
| Numbers of burners | 3 |
| Dimension | 470x360 mm |
| Power | A 1 kW / SR 1.7 kW / R 3.0 kW |
| Energy Consumption | (A 73g/h) (SR 124g/h) (R 218g/h) |
| Supply gas | GPL 28-30 mbar |
| Safety device | Thermocouple |
| Material | Aisi304 Stainless Steel |
| Weight | 4 Kg |



PACKAGE DIMENSION
560X430X180 mm



PACKAGE WEIGHT
5,5 Kg



PACKAGES FOR PALLET
36 (900X120X120) 210 Kg

| PRODUCT | | FEATURES / SPECIFICATIONS / ACCESSORIES | | | |
|---------|----------|---|-----------------|------------------|-------------|
| MODEL | IGNITION | VERSION | MANUAL LIGHTING | SINGLE PACKAGING | ART. NUMBER |
| PC1323 | S | | ● | — | PC1323-S |
| PC1323 | S | GR | ● | ● | PC1323-S-GR |

S MANUAL LIGHTING | P PIEZOMECHANIC IGNITION | E 12V ELECTRONIC IGNITION



DISCOVER
MORE AT
AIRXCEL.EU



FOLDY

Everything concealed

The space of a sink can enclose much more. This is why CAN has created Foldy: the kitchen-unit with the concealed hob. The tempered glass burner support, once closed, disappears within the sink, hiding the hob and creating a practical table top.

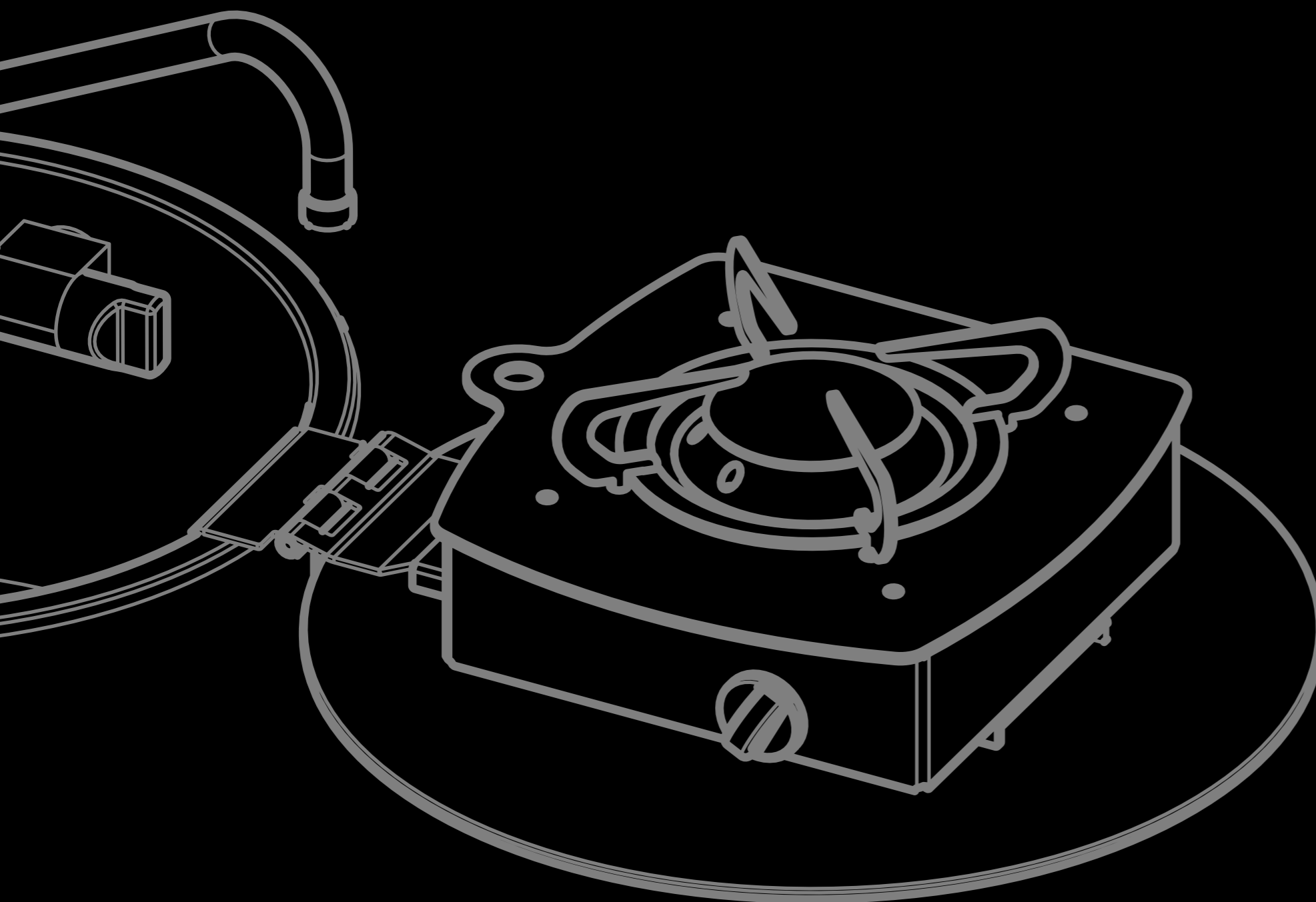

LC1701

72

LC1710

73



LC1701

Combined round N°1 turning burner SR.

Compact round 1-burner stainless steel hinged stove equipped with self-locking lid, complete with sink and folding cold water tap (Cod. RB1486). The top is equipped with a tempered glass lid.

| | |
|--------------------|-------------------------|
| Numbers of burners | 1 |
| Dimension | 350x320 mm |
| Power | SR 1.7 kW |
| Energy Consumption | (SR 124g/h) |
| Supply gas | GPL 28-30 mbar |
| Safety device | Thermocouple |
| Material | Aisi304 Stainless Steel |
| Weight | 6 Kg |



PACKAGE DIMENSION
400X380X250 mm



PACKAGE WEIGHT
7,5 Kg



PACKAGES FOR PALLET
54 (120X120X170) 180 Kg

| PRODUCT | | | FEATURES / SPECIFICATIONS / ACCESSORIES | | | | | | |
|---------|----------|---------|---|---|---|--|---|------------------|-------------|
| MODEL | IGNITION | VERSION | MANUAL LIGHTING |  600025 RUBBER SEAL |  WASTE LP1800 |  RB1486 COLD WATER |  RB1853 HOT AND COLD WATER | SINGLE PACKAGING | ART. NUMBER |
| LC1701 | S | | ● | — | ● | ● | — | ● | LC1701-S |
| LC1701 | S | RE | ● | — | ● | — | ● | ● | LC1701-S-RE |

S MANUAL LIGHTING | P PIEZOMECHANIC IGNITION | E 12V ELECTRONIC IGNITION



DOWNLOAD
MANUAL
INSTRUCTIONS



LC1710

Combined square N°1 turning burner SR.

Compact rectangular 1-burner stainless steel hinged stove equipped with self-locking lid, complete with sink and folding cold water tap (Cod. RB1486). The top is equipped with a tempered glass lid.



| | |
|--------------------|-------------------------|
| Numbers of burners | 1 |
| Dimension | 350x320 mm |
| Power | SR 1.7 kW |
| Energy Consumption | (SR 124g/h) |
| Supply gas | GPL 28-30 mbar |
| Safety device | Thermocouple |
| Material | Aisi304 Stainless Steel |
| Weight | 6 Kg |



PACKAGE DIMENSION
400X380X250 mm



PACKAGE WEIGHT
7,5 Kg



PACKAGES FOR PALLET
54 (120X120X170) 180 Kg

| PRODUCT | | | FEATURES / SPECIFICATIONS / ACCESSORIES | | | | | | |
|---------|----------|---------|---|---|---|--|--|------------------|-------------|
| MODEL | IGNITION | VERSION | MANUAL LIGHTING |  600025 RUBBER SEAL |  WASTE LP1800 |  RB1486 COLD WATER |  RB1853 HOT AND COLD WATER | SINGLE PACKAGING | ART. NUMBER |
| LC1710 | S | | ● | — | ● | ● | — | ● | LC1710-S |
| LC1710 | S | RE | ● | — | ● | — | ● | ● | LC1710-S-RE |

S MANUAL LIGHTING | P PIEZOMECHANIC IGNITION | E 12V ELECTRONIC IGNITION



DOWNLOAD
MANUAL
INSTRUCTIONS



ELECTRICAL COOKING UNITS

The alternative to gas

Vitroceramic, induction, grill and electrical plates: if cooking by gas is not possible, CAN offer several alternatives. Electrical power supply has allowed the development of different style hobs, designed and produced with the same attention to detail.

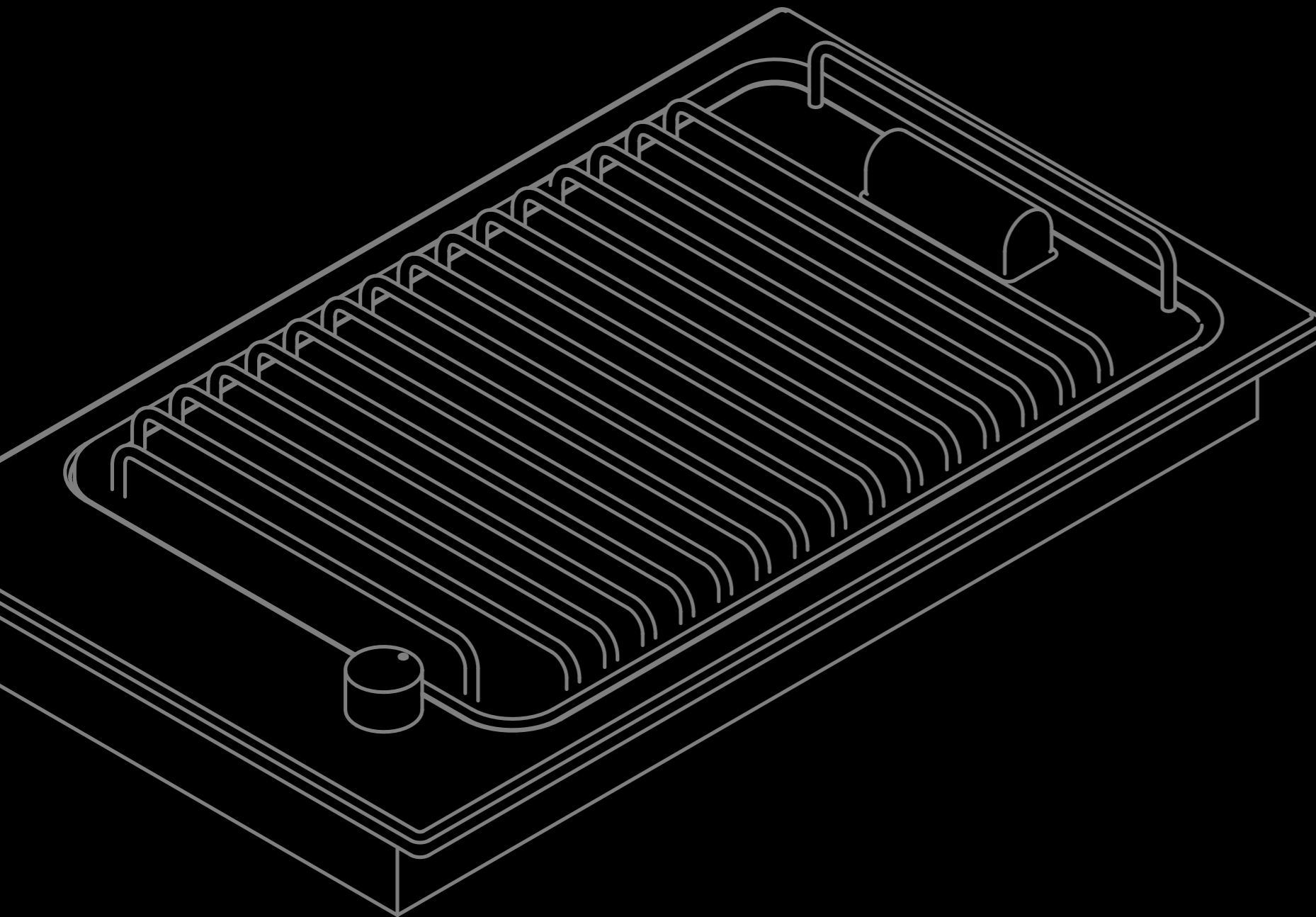

| | | | |
|--------|----|--------|----|
| PI3050 | 76 | PB1327 | 79 |
| PT1356 | 77 | PB1328 | 80 |
| PT1358 | 78 | PTS121 | 81 |

PI3050

Induction hob-unit N°2 cooking zone.

Built-in ceramic stove with 2 induction cooking zones.



| | |
|--------------------------|--|
| Numbers of cooking zones | 2 |
| Dimension | 300x505x60 mm |
| Power | Zone 1 Ø 145 mm 1200W Zone 2 Ø 210 mm 1600W |
| Energy Consumption | Zone 1: 176.4 Wh/Kg Zone 2: 183,4 Wh/Kg Stove: 179.9 Wh/Kg |
| Supply | 220-240 V Frequency: 50/60 Hz |
| Safety device | Key lock |
| Heating Technology | Induction |
| Weight | 5 Kg |
| Material | Glass-ceramic |

 **PACKAGE DIMENSION**
310X520X120 mm

 **PACKAGE WEIGHT**
7 Kg

 **PACKAGES FOR PALLET**
32 (80X120X140) 240 Kg



**DOWNLOAD
MANUAL
INSTRUCTIONS**



PT1356

Flush mounting vitroceramic hob-unit N°2 cooking zone.

Built-in ceramic stove with 2 radiating 220 V plates with "touch screen" control.



| | |
|--------------------------|--|
| Numbers of cooking zones | 2 |
| Dimension | 285x505x60 mm |
| Power | Zone 1 Ø 145 mm 1200W Zone 2 Ø 210 mm 1600W |
| Energy Consumption | Zone 1: 176.4 Wh/Kg Zone 2: 183,4 Wh/Kg Stove: 179.9 Wh/Kg |
| Supply | 220-240 V Frequency: 50/60 Hz |
| Safety device | Key lock |
| Heating Technology | Radiating elements |
| Material | Glass-ceramic |
| Weight | 5 Kg |

 **PACKAGE DIMENSION**
310X520X120 mm

 **PACKAGE WEIGHT**
7 Kg

 **PACKAGES FOR PALLET**
32 (80X120X140) 240 Kg



**DOWNLOAD
MANUAL
INSTRUCTIONS**

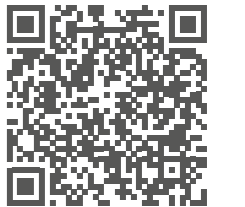

PT1358

Flush mounting vitroceramic hob-unit N°4 cooking zone.

Built-in ceramic stove with 4 radiating 220 V plates with "touch screen" control.

| | |
|--------------------------|--|
| Numbers of cooking zones | 4 |
| Dimension | 580x505x50 mm |
| Power | Zone 1 Ø 145 mm 1200W Zone 2 Ø 210 mm 1600W Zone 3 Ø 145 mm 1200W Zone 4 Ø 210 mm 1600W |
| Energy Consumption | "Zone 1: 176.4 Wh/Kg Zone 2: 183.4 Wh/Kg Zone 3: 176.4 Wh/Kg Zone 4: 183.4 Wh/Kg Stove: 179.9 Wh/Kg" |
| Supply | 220-240 V Frequency: 50/60 Hz |
| Safety device | Key lock |
| Heating Technology | Radiating elements |
| Weight | 8 Kg |
| Material | Glass-ceramic |



 **PACKAGE DIMENSION**
610X520X120 mm

 **PACKAGE WEIGHT**
10 Kg

 **PACKAGES FOR PALLET**
32 (80X120X140) 330 Kg



**DOWNLOAD
MANUAL
INSTRUCTIONS**





PB1327

Flush mounting electric barbecue with lava stone.

Built-in stainless steel stove with lava stones and electric grill at 2400 Watt - 220 V.

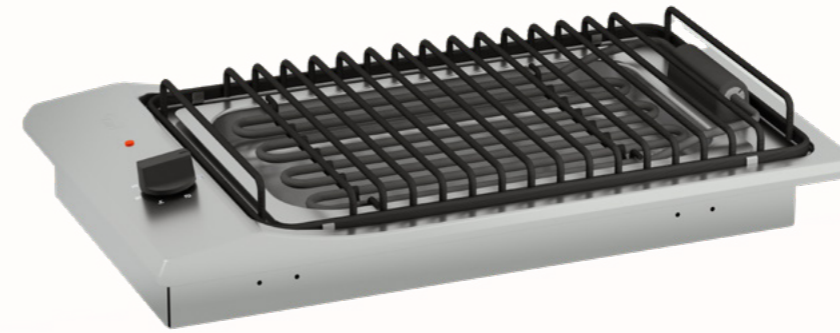
| | |
|--------------------|--------------------------------|
| Numbers of burners | 1 |
| Dimension | 300x500x55 mm |
| Power | 2400 kW |
| Supply | 220-240 V Frequency: 50/60 Hz |
| Power On | Radiating element / Resistance |
| Weight | 7 Kg |
| Material | Steel with enameled grill |



 **PACKAGE DIMENSION**
310X520X120 mm

 **PACKAGE WEIGHT**
9 Kg

 **PACKAGES FOR PALLET**
32 (80X120X140) 300Kg



**DOWNLOAD
MANUAL
INSTRUCTIONS**

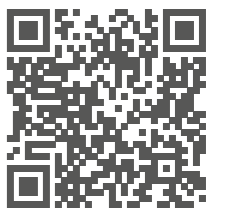

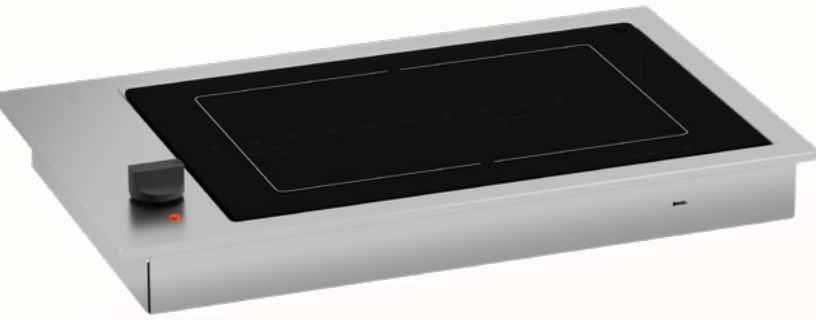

PB1328

Flush mounting electric hob.

Built-in stove with stainless steel structure, barbeque in striped glass-ceramic at 2400 Watt - 220 V.

| | |
|--------------------|--------------------------------|
| Numbers of burners | 1 |
| Dimension | 305x510x60 mm |
| Power | 2500 kW |
| Supply | 220-240 V Frequency: 50/60 Hz |
| Power On | Radiating element / Resistance |
| Weight | 5,5 Kg |
| Material | Striped glass-ceramic |

 **PACKAGE DIMENSION**
310X520X120 mm

 **PACKAGE WEIGHT**
7,5 Kg

 **PACKAGES FOR PALLET**
32 (80X120X140) 300 Kg



**DOWNLOAD
MANUAL
INSTRUCTIONS**



NEW!



PTS121

High efficiency, low consumption, thin design.
Portable induction cooktop

With its light and super thin design, Can's new induction hob offers extreme portability and energy efficiency, ensuring the best cooking experience.

| | |
|--------------------|-------------------------------|
| Numbers of burners | 1 |
| Dimension | 300X370X24 mm |
| Power | 2100 W |
| Supply | 220-240 V Frequency: 50/60 Hz |
| Power On | Induction |
| Weight | 3 Kg |
| Material | Glass-ceramic |

 **PACKAGE DIMENSION**
370X500X95 mm

 **PACKAGE WEIGHT**
4 Kg

 **PACKAGES FOR PALLET**
N/A



**TRAVEL CASE
INCLUDED**

**DISCOVER
MORE AT
AIRXCEL.EU**

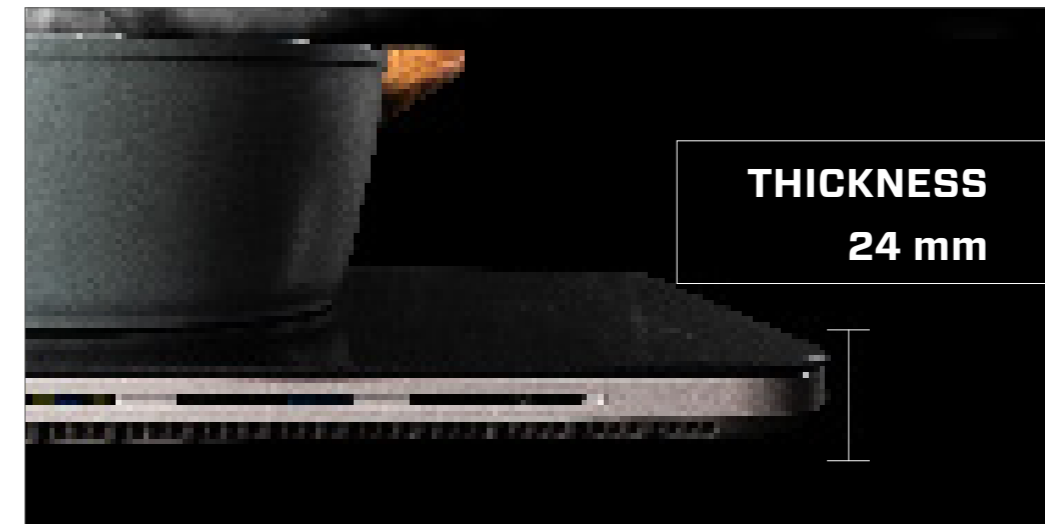
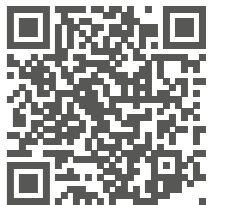

**THICKNESS
24 mm**

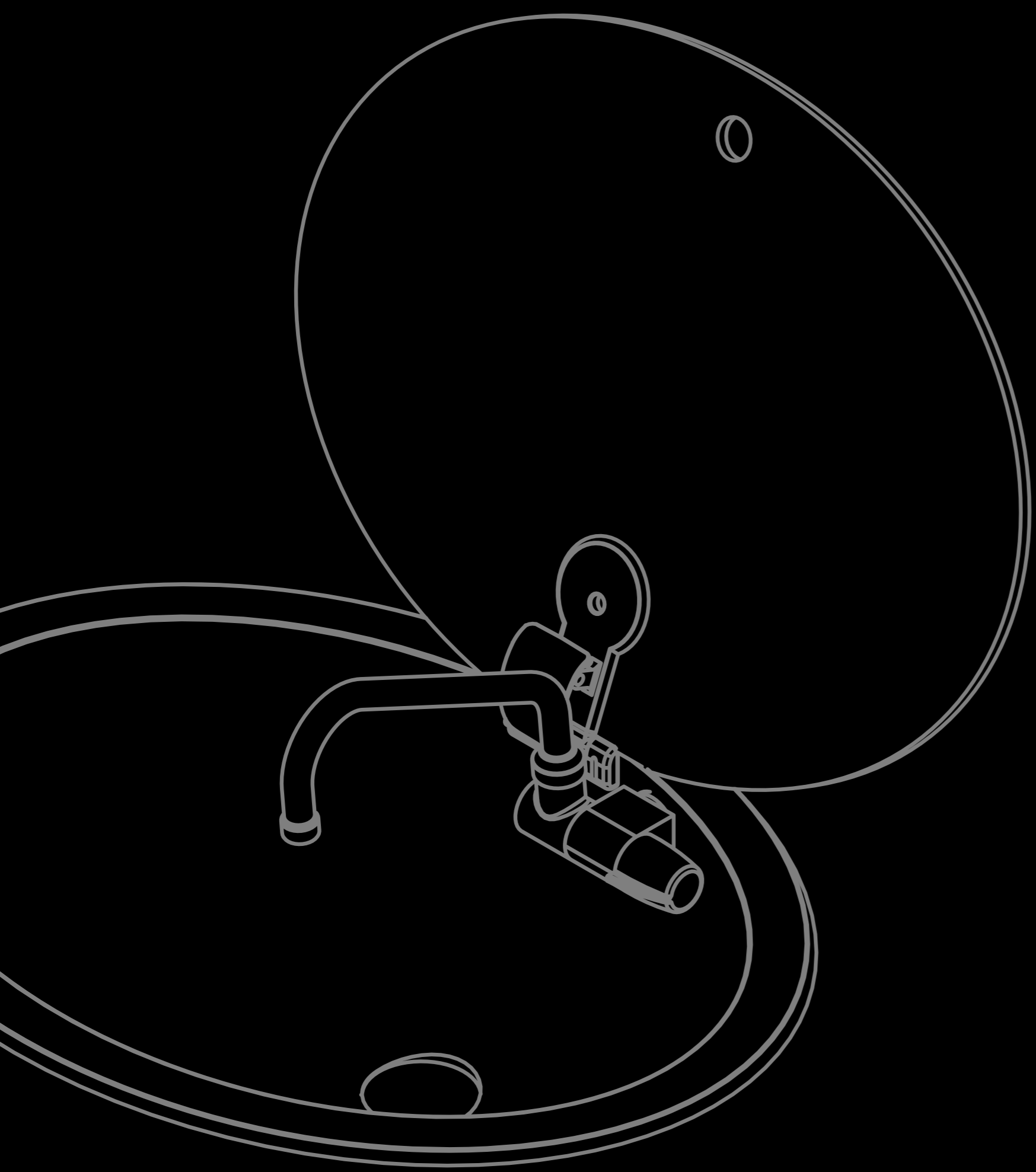

SINKS WITH FAUCET

And the sink disappears

The CAN stainless steel sinks are fully customisable due to the shapes and accessories offered. They're available in oval, round, or square shapes, and with different faucet variations. What do they have in common? Extreme attention to overall dimension and design: that can give a new table top with minimal space.

| | | | |
|--------|----|--------|----|
| LR1375 | 84 | LR1762 | 87 |
| LR1405 | 85 | LR1770 | 88 |
| LR1760 | 86 | | |





LR1375

Rectangular sink with tempered glass cover.

Compact rectangular sink in scotch-brite stainless steel, equipped with tempered glass lid.

| | |
|-----------|-------------------------|
| Dimension | 375x300x125 mm |
| Finish | Scotch-brite |
| Weight | 4 Kg |
| Material | Aisi304 Stainless Steel |



PACKAGE DIMENSION
400X370X240 mm



PACKAGE WEIGHT
5 Kg



PACKAGES FOR PALLET
63 (120X120X190) 325 Kg



LR1405

Rectangular sink with tempered glass cover.

Compact rectangular sink in scotch-brite stainless steel, equipped with tempered glass lid.

| | |
|-----------|-------------------------|
| Dimension | 355x290x140 mm |
| Finish | Scotch-brite |
| Weight | 4 Kg |
| Material | Aisi304 Stainless Steel |



PACKAGE DIMENSION
400X370X240 mm



PACKAGE WEIGHT
5 Kg



PACKAGES FOR PALLET
63 (120X120X190) 325 Kg

| PRODUCT | | FEATURES / SPECIFICATIONS / ACCESSORIES | | | | | |
|---------|---------|---|---|--|---|------------------|-------------|
| MODEL | VERSION |  600025 RUBBER SEAL |  WASTE LP1800 |  RB1487 COLD WATER |  RB1488 HOT AND COLD WATER | SINGLE PACKAGING | ART. NUMBER |
| LR1375 | | — | — | — | — | — | LR1375 |
| LR1375 | GR | ● | ● | — | — | ● | LR1375-GR |



DISCOVER
MORE AT
AIRXCEL.EU

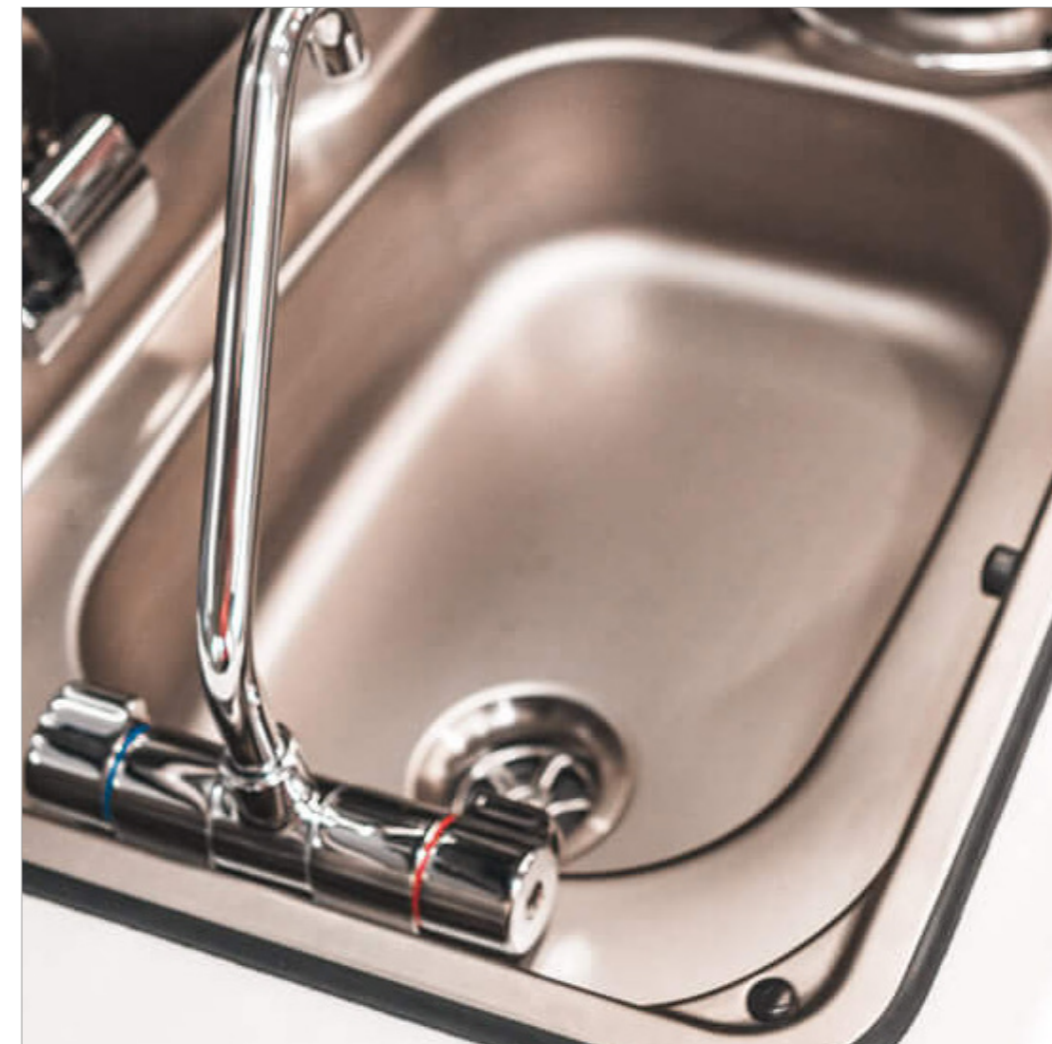

DISCOVER
MORE AT
AIRXCEL.EU







LR1760

Rectangular sink with tempered glass cover.

Compact rectangular sink in semi-gloss stainless steel, equipped with tempered glass lid and folding cold water tap (Cod. RB1486)."

| | |
|-----------|------------------------------|
| Dimension | 350x320x150 mm |
| Finish | Semi-gloss |
| Weight | 4,5 Kg |
| Water Tap | Included (RB1486 cold water) |
| Material | Aisi304 Stainless Steel |

 PACKAGE DIMENSION
400X370X240 mm

 PACKAGE WEIGHT
5,5 Kg

 PACKAGES FOR PALLET
63 (120X120X190) 360 Kg





LR1762

Rectangular sink with tempered glass cover.

Compact rectangular sink in semi-gloss stainless steel, equipped with tempered glass lid and folding cold water tap (Cod. RB1486)."

| | |
|-----------|------------------------------|
| Dimension | 350x320x90 mm |
| Finish | Semi-gloss |
| Weight | 3 Kg |
| Water Tap | Included (RB1486 cold water) |
| Material | Aisi304 Stainless Steel |

 PACKAGE DIMENSION
360X330X140 mm

 PACKAGE WEIGHT
4 Kg

 PACKAGES FOR PALLET
80 (80X120X180) 330 Kg

| PRODUCT | | FEATURES / SPECIFICATIONS / ACCESSORIES | | | | | |
|---------|---------|---|---|--|--|---------------------|-------------|
| MODEL | VERSION |  600025 RUBBER SEAL |  WASTE LP1800 |  RB1486 COLD WATER |  RB1853 HOT AND COLD WATER | SINGLE PACKAGING | ART. NUMBER |
| LR1760 | | — | ● | ● | — | — | LR1760 |
| LR1760 | GR | ● | ● | ● | — | ● | LR1760-GR |



DISCOVER
MORE AT
AIRXCEL.EU



DISCOVER
MORE AT
AIRXCEL.EU





LR1770

Round sink with tempered glass cover.

Compact round sink scotch-brite finish with tempered glass. Tap not included.

| | |
|-----------------------|-------------------------|
| Dimension | Ø 407x150 mm |
| Finish | Scotch-brite |
| Weight | 4 Kg |
| Water Tap Hole | Ø 33 - Tap not included |
| Material | Aisi304 Stainless Steel |





PACKAGE DIMENSION
520X520X200 mm



PACKAGE WEIGHT
5 Kg



PACKAGES FOR PALLET
36 (114X114X200) 190 Kg

| PRODUCT | | FEATURES / SPECIFICATIONS / ACCESSORIES | | | | | |
|---------|---------|---|---|--|---|------------------|-------------|
| MODEL | VERSION |  600025 RUBBER SEAL |  WASTE LP1800 |  RB1487 COLD WATER |  RB1488 HOT AND COLD WATER | SINGLE PACKAGING | ART. NUMBER |
| LR1770 | | — | — | — | — | — | LR1770 |
| LR1770 | GR | ● | ● | — | — | ● | LR1770-GR |



DISCOVER
MORE AT
AIRXCEL.EU



SINKS

All the shapes of the water

For CAN, design is function and much more. The shape can become pure aesthetics and the opportunity to enhance the excellence of stainless steel, or of other materials. Sinks are an example, whether square, hemispheric, elliptical in stainless steel or glass. The architecture of every kitchen can thus always find a perfect recessed solution with customised shapes and dimensions.

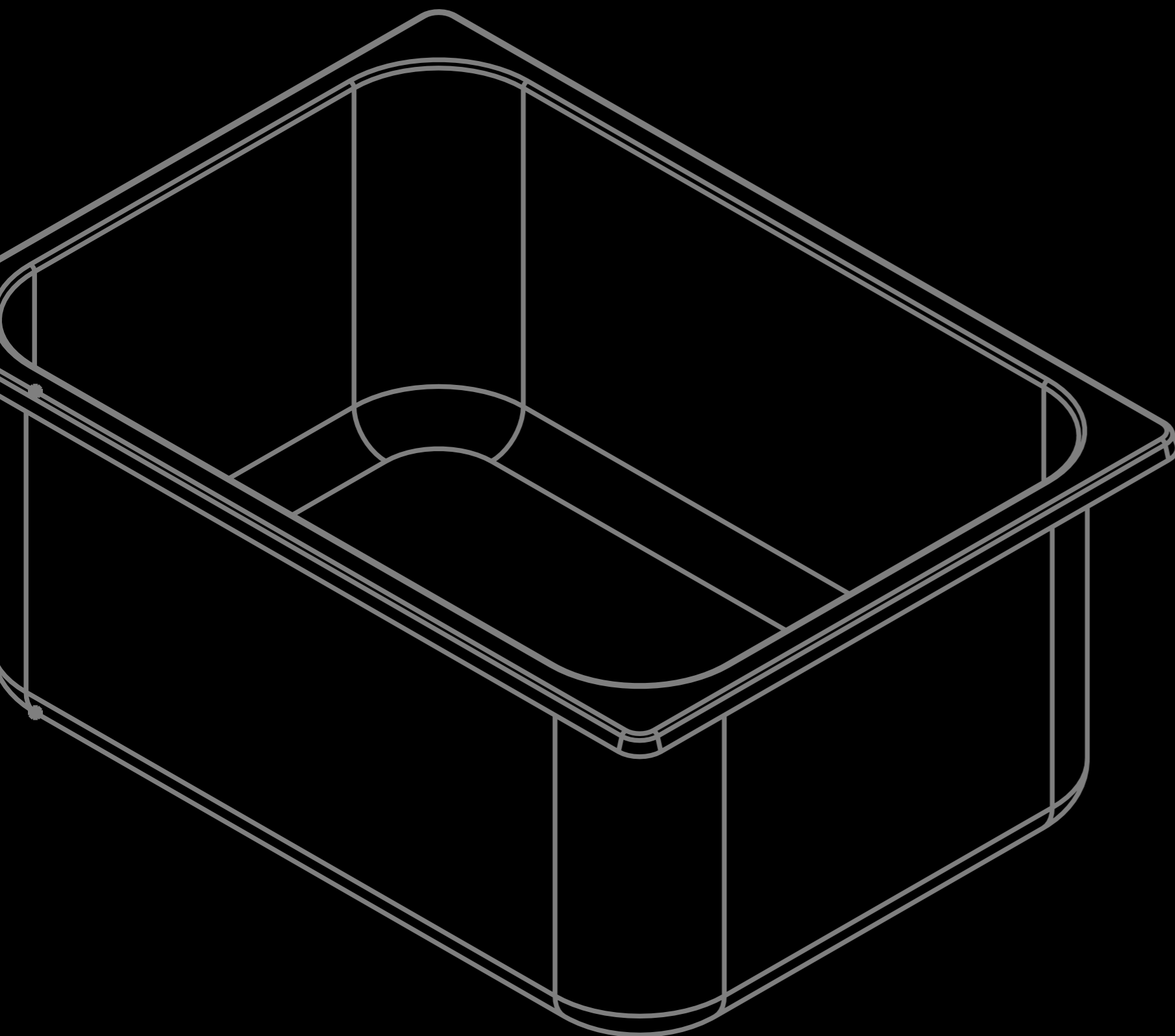

| | | | |
|--------|----|----------|----|
| LA1400 | 92 | LA1410 | 95 |
| LA1401 | 92 | LA1411 | 95 |
| LA1402 | 93 | LA1417 | 96 |
| LA1403 | 93 | LA1418 | 96 |
| LA1404 | 94 | LA1418BA | 97 |
| LA1405 | 94 | LA1403BA | 97 |



LA1400

Rectangular semipolish sink.





Semi-gloss stainless steel rectangular sink.

| | |
|------------------|-------------------------|
| Dimension | 355x260x150 mm |
| Finish | Semi-gloss |
| Weight | 1 Kg |
| Material | Aisi304 Stainless Steel |

 **PACKAGE DIMENSION**
400X380X250 mm

 **PACKAGE WEIGHT**
1,5 Kg

 **PACKAGES FOR PALLET**
63 (120X120X190) 105 Kg

| PRODUCT | | FEATURES / SPECIFICATIONS / ACCESSORIES | | | | | |
|---------|---------|--|--|---|---|---------------------|-------------|
| MODEL | VERSION |  600025 RUBBER SEAL |  WASTE LP1800 |  RB1487 COLD WATER |  RB1488 HOT AND COLD WATER | SINGLE PACKAGING | ART. NUMBER |
| LA1400 | | — | — | — | — | — | LA1400 |
| LA1400 | GR | ● | ● | — | — | ● | LA1400-GR |





LA1402

Rectangular semipolish sink.





Semi-gloss stainless steel rectangular sink.

| | |
|------------------|-----------------------|
| Dimension | 350x320x150 mm |
| Finish | Semi-gloss |
| Weight | 1,5 Kg |
| Material | Stainless steel 304 L |

 **PACKAGE DIMENSION**
400X380X250 mm

 **PACKAGE WEIGHT**
2 Kg

 **PACKAGES FOR PALLET**
63 (120X120X190) 140 Kg

| PRODUCT | | FEATURES / SPECIFICATIONS / ACCESSORIES | | | | | |
|---------|---------|--|--|---|--|---------------------|-------------|
| MODEL | VERSION |  600025 RUBBER SEAL |  WASTE LP1800 |  RB1487 COLD WATER |  RB1488 HOT AND COLD WATER | SINGLE PACKAGING | ART. NUMBER |
| LA1402 | | — | — | — | — | — | LA1402 |
| LA1402 | GR | ● | ● | — | — | ● | LA1402-GR |



LA1401

Rectangular semipolish sink.

Semi-gloss stainless steel rectangular sink.

| | |
|------------------|-----------------------|
| Dimension | 355x260x150 mm |
| Finish | Semi-gloss |
| Weight | 1,3 Kg |
| Material | Stainless steel 304 L |

 **PACKAGE DIMENSION**
400X380X250 mm

 **PACKAGE WEIGHT**
1,5 Kg

 **PACKAGES FOR PALLET**
63 (120X120X190) 105 Kg

| PRODUCT | | FEATURES / SPECIFICATIONS / ACCESSORIES | | | | | |
|---------|---------|--|--|---|---|---------------------|-------------|
| MODEL | VERSION |  600025 RUBBER SEAL |  WASTE LP1800 |  RB1487 COLD WATER |  RB1488 HOT AND COLD WATER | SINGLE PACKAGING | ART. NUMBER |
| LA1401 | | — | — | — | — | — | LA1401 |
| LA1401 | GR | — | ● | — | — | ● | LA1401-GR |





LA1403

Square semipolish sink.



Semi-gloss stainless steel square sink.

| | |
|------------------|-----------------------|
| Dimension | 360x360x150 mm |
| Finish | Semi-gloss |
| Weight | 1,6 Kg |
| Material | Stainless steel 304 L |

 **PACKAGE DIMENSION**
400X380X250 mm

 **PACKAGE WEIGHT**
2,2 Kg

 **PACKAGES FOR PALLET**
63 (120X120X190) 150 Kg

| PRODUCT | | FEATURES / SPECIFICATIONS / ACCESSORIES | | | | | |
|---------|---------|--|--|---|--|---------------------|-------------|
| MODEL | VERSION |  600025 RUBBER SEAL |  WASTE LP1800 |  RB1487 COLD WATER |  RB1488 HOT AND COLD WATER | SINGLE PACKAGING | ART. NUMBER |
| LA1403 | | — | — | — | — | — | LA1403 |
| LA1403 | GR | ● | ● | — | — | ● | LA1403-GR |



LA1404

Rectangular semipolish sink.





Semi-gloss stainless steel rectangular sink.

| | |
|------------------|-----------------------|
| Dimension | 170x320x150 mm |
| Finish | Semi-gloss |
| Weight | 0,8 Kg |
| Material | Stainless steel 304 L |

 **PACKAGE DIMENSION**
400X380X250 mm

 **PACKAGE WEIGHT**
1,5 Kg

 **PACKAGES FOR PALLET**
63 (120X120X190) 105 Kg

| PRODUCT | | FEATURES / SPECIFICATIONS / ACCESSORIES | | | | | |
|---------|---------|--|--|---|--|------------------|-------------|
| MODEL | VERSION |  600025 RUBBER SEAL |  WASTE LP1800 |  RB1487 COLD WATER |  RB1488 HOT AND COLD WATER | SINGLE PACKAGING | ART. NUMBER |
| LA1404 | | — | — | — | — | — | LA1404 |
| LA1404 | GR | ● | ● | — | — | ● | LA1404-GR |





LA1410

Semispheric mirror polish sink.





Mirror polished stainless steel semi-spherical sink.

| | |
|------------------|-----------------------|
| Dimension | Ø 290x120 mm |
| Finish | Mirror Polish |
| Weight | 0,6 Kg |
| Material | Stainless steel 304 L |

 **PACKAGE DIMENSION**
400X380X250 mm

 **PACKAGE WEIGHT**
1,5 Kg

 **PACKAGES FOR PALLET**
63 (120X120X190) 105 Kg

| PRODUCT | | FEATURES / SPECIFICATIONS / ACCESSORIES | | | | | |
|---------|---------|--|--|---|---|------------------|-------------|
| MODEL | VERSION |  600025 RUBBER SEAL |  WASTE LP1800 |  RB1487 COLD WATER |  RB1488 HOT AND COLD WATER | SINGLE PACKAGING | ART. NUMBER |
| LA1410 | | — | — | — | — | — | LA1410 |
| LA1410 | GR | ● | ● | — | — | ● | LA1410-GR |



LA1405

Rectangular semipolish sink.



Semi-gloss stainless steel rectangular sink.

| | |
|------------------|-----------------------|
| Dimension | 355x290x140 mm |
| Finish | Semi-gloss |
| Weight | 1 Kg |
| Material | Stainless steel 304 L |

 **PACKAGE DIMENSION**
400X380X250 mm

 **PACKAGE WEIGHT**
2 Kg

 **PACKAGES FOR PALLET**
63 (120X120X190) 140 Kg

| PRODUCT | | FEATURES / SPECIFICATIONS / ACCESSORIES | | | | | |
|---------|---------|--|--|---|--|------------------|-------------|
| MODEL | VERSION |  600025 RUBBER SEAL |  WASTE LP1800 |  RB1487 COLD WATER |  RB1488 HOT AND COLD WATER | SINGLE PACKAGING | ART. NUMBER |
| LA1405 | | — | — | — | — | — | LA1405 |
| LA1405 | GR | ● | ● | — | — | ● | LA1405-GR |





LA1411

Semispheric mirror polish sink.





Mirror polished stainless steel semi-spherical sink.

| | |
|------------------|-----------------------|
| Dimension | 360x360x150 mm |
| Finish | Semi-gloss |
| Weight | 1,6 Kg |
| Material | Stainless steel 304 L |

 **PACKAGE DIMENSION**
400X380X250 mm

 **PACKAGE WEIGHT**
2,2 Kg

 **PACKAGES FOR PALLET**
63 (120X120X190) 150 Kg

| PRODUCT | | FEATURES / SPECIFICATIONS / ACCESSORIES | | | | | |
|---------|---------|--|--|---|---|------------------|-------------|
| MODEL | VERSION |  600025 RUBBER SEAL |  WASTE LP1800 |  RB1487 COLD WATER |  RB1488 HOT AND COLD WATER | SINGLE PACKAGING | ART. NUMBER |
| LA1411 | | — | — | — | — | — | LA1411 |
| LA1411 | GR | ● | ● | — | — | ● | LA1411-GR |



LA1417

Semispheric mirror polish sink.

Mirror polished stainless steel semi-spherical sink.

| | |
|------------------|-----------------------|
| Dimension | 170x320x150 mm |
| Finish | Semi-gloss |
| Weight | 0,8 Kg |
| Material | Stainless steel 304 L |

 **PACKAGE DIMENSION**
400X380X250 mm

 **PACKAGE WEIGHT**
1,5 Kg

 **PACKAGES FOR PALLET**
63 (120X120X190) 105 Kg





LA1418BA

Round scotch-brite finish sink.





Scotch-brite stainless steel round sink.





| | |
|------------------|-----------------------|
| Dimension | Ø 385x120 mm |
| Finish | Scotch-brite |
| Weight | 1,5 Kg |
| Material | Stainless steel 304 L |

 **PACKAGE DIMENSION**
400X380X250 mm

 **PACKAGE WEIGHT**
2,5 Kg

 **PACKAGES FOR PALLET**
63 (120X120X190) 170 Kg

| PRODUCT | | FEATURES / SPECIFICATIONS / ACCESSORIES | | | | | |
|---------|---------|--|--|---|--|------------------|-------------|
| MODEL | VERSION |  600025 RUBBER SEAL |  WASTE LP1800 |  RB1487 COLD WATER |  RB1488 HOT AND COLD WATER | SINGLE PACKAGING | ART. NUMBER |
| LA1417 | | — | — | — | — | — | LA1417 |
| LA1417 | GR | ● | ● | — | — | ● | LA1417-GR |

| PRODUCT | | FEATURES / SPECIFICATIONS / ACCESSORIES | | | | | |
|----------|---------|--|--|---|---|------------------|-------------|
| MODEL | VERSION |  600025 RUBBER SEAL |  WASTE LP1800 |  RB1487 COLD WATER |  RB1488 HOT AND COLD WATER | SINGLE PACKAGING | ART. NUMBER |
| LA1418BA | | — | — | — | — | — | LA1418BA |
| LA1418BA | GR | ● | ● | — | — | ● | LA1418BA-GR |



LA1418

Round mirror polish sink.

Mirror polished stainless steel round sink.

| | |
|------------------|-----------------------|
| Dimension | Ø 385x150 mm |
| Finish | Mirror Polish |
| Weight | 1,8 Kg |
| Material | Stainless steel 304 L |

 **PACKAGE DIMENSION**
400X380X250 mm

 **PACKAGE WEIGHT**
2,5 Kg

 **PACKAGES FOR PALLET**
63 (120X120X190) 170 Kg





LA1403BA

Square scotch-brite finish sink.



Scotch-brite stainless steel square sink.





| | |
|------------------|-----------------------|
| Dimension | 360x360x150 mm |
| Finish | Scotch-brite |
| Weight | 1,6 Kg |
| Material | Stainless steel 304 L |

 **PACKAGE DIMENSION**
400X380X250 mm

 **PACKAGE WEIGHT**
2,5 Kg

 **PACKAGES FOR PALLET**
63 (120X120X190) 170 Kg

| PRODUCT | | FEATURES / SPECIFICATIONS / ACCESSORIES | | | | | |
|---------|---------|--|--|---|--|------------------|-------------|
| MODEL | VERSION |  600025 RUBBER SEAL |  WASTE LP1800 |  RB1487 COLD WATER |  RB1488 HOT AND COLD WATER | SINGLE PACKAGING | ART. NUMBER |
| LA1418 | | — | — | — | — | — | LA1418 |
| LA1418 | GR | ● | ● | — | — | ● | LA1418-GR |

| PRODUCT | | FEATURES / SPECIFICATIONS / ACCESSORIES | | | | | |
|----------|---------|--|--|---|---|------------------|-------------|
| MODEL | VERSION |  600025 RUBBER SEAL |  WASTE LP1800 |  RB1487 COLD WATER |  RB1488 HOT AND COLD WATER | SINGLE PACKAGING | ART. NUMBER |
| LA1403BA | | — | — | — | — | — | LA1403BA |
| LA1403BA | GR | ● | ● | — | — | ● | LA1403BA-GR |

OUTDOOR

Hobs as supports: always free to cook

When a dedicated cooking area is not needed, but it is the freedom of action to guide the choice of the ideal stove, CAN offer the support solutions. The gas stoves of the Hotty line allow a free installation and make every surface a perfect hob, to cook hot meals in any situation.

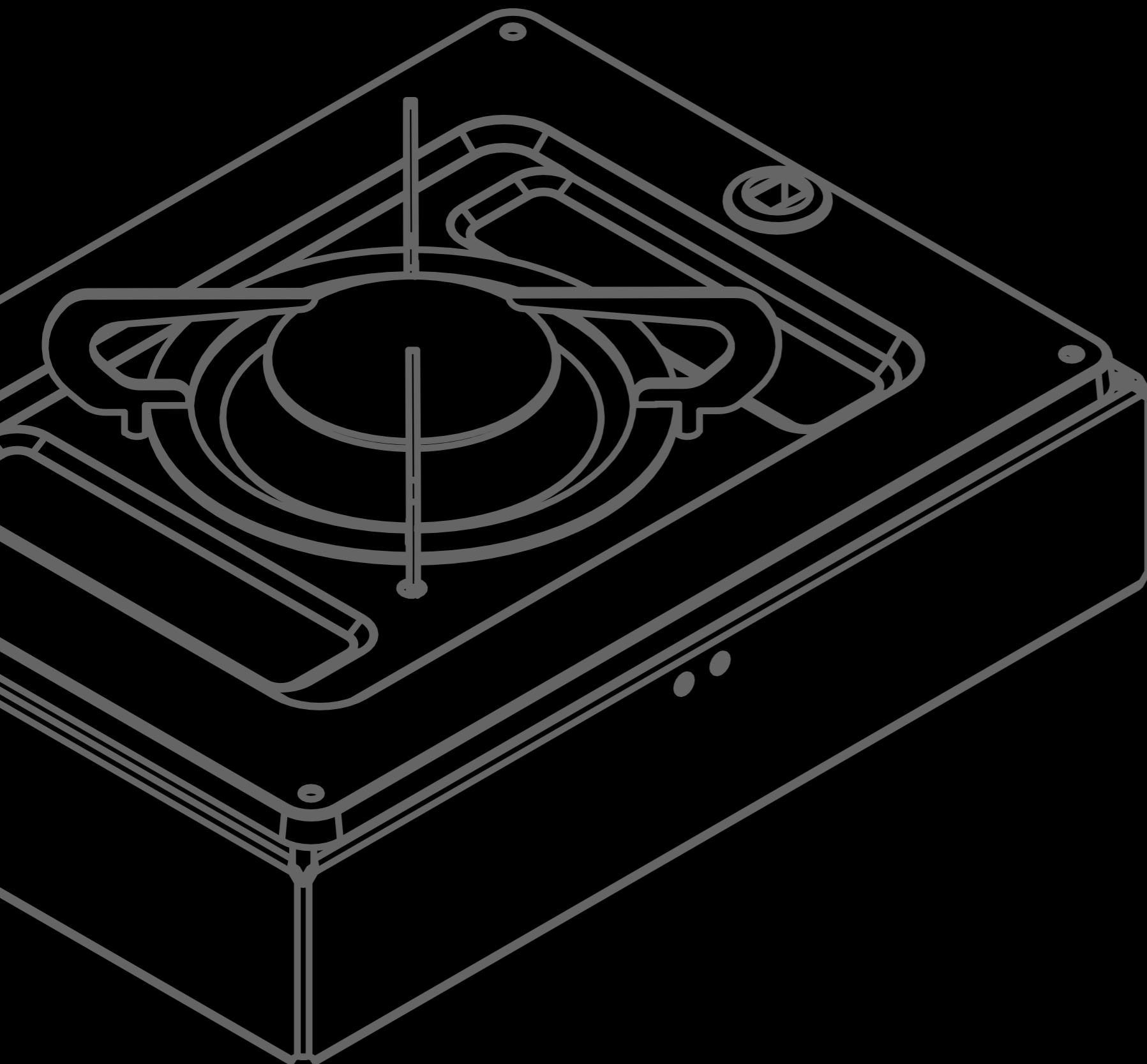

| | | | |
|--------|-----|--------|-----|
| FN1330 | 100 | FN1333 | 101 |
| FN1332 | 100 | | |



FN1330

Gas stoves N°1 burner SR.

Gas stove in mirror polished stainless steel with fixing brackets interchangeable with the CAN gimbal system.

| | |
|--------------------|-----------------------|
| Numbers of burners | 1 |
| Dimension | 210x290x90 mm |
| Power | SR 1.7 kW |
| Energy Consumption | (SR 124g/h) |
| Supply gas | GPL 28-30 mbar |
| Safety device | Thermocouple |
| Weight | 2 Kg |
| Power On | Manual Lighting |
| Material | Stainless steel 304 L |

DISCOVER MORE AT
AIRXCEL.EU



PACKAGE DIMENSION
370X340X140 mm



PACKAGE WEIGHT
3 Kg



PACKAGES FOR PALLET
60 (80X120X180) 190 Kg

NEW!



FN1333

2 Burners gas stove, enamelled burners-cap, enamelled gate. Color: Graphite grey.

| | |
|--------------------|---------------------|
| Numbers of burners | 2 |
| Dimension | 440x290x90mm |
| Power | A 1 kW / SR 1.7 kW |
| Energy Consumption | (A73g/h)(SR 124g/h) |
| Supply gas | GPL 28-30 mbar |
| Safety device | Thermocouple |
| Weight | 4 Kg |
| Power On | Manual Lighting |



PACKAGE DIMENSION
500X370X170 mm



PACKAGE WEIGHT
5,5 Kg



PACKAGES FOR PALLET
54 (80X120X220) 310 Kg



FN1332

Gas stoves N°2 burners A-SR.

Gas stove in mirror polished stainless steel with interchangeable fixing brackets for the CAN gimbal system.

| | |
|--------------------|-----------------------|
| Numbers of burners | 2 |
| Dimension | 440x290x90mm |
| Power | A 1 kW / SR 1.7 kW |
| Energy Consumption | (A73g/h)(SR 124g/h) |
| Supply gas | GPL 28-30 mbar |
| Safety device | Thermocouple |
| Weight | 4 Kg |
| Power On | Manual Lighting |
| Material | Stainless steel 304 L |

DISCOVER MORE AT
AIRXCEL.EU



PACKAGE DIMENSION
590X400X230 mm



PACKAGE WEIGHT
5 Kg



PACKAGES FOR PALLET
36 (80X120X180) 190 Kg



DISCOVER
MORE AT
AIRXCEL.EU

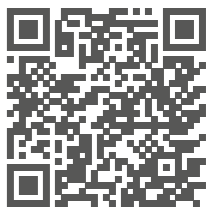

URBAN HYBRID

New urban hybrid cooktop

Hybrid home appliances two/ three independently zone:
induction and gas.

HC0550 104

HC0770 106

HC0635T 105

NEW FROM 2025!

HC0550

Urban Hybrid 1+1 Gas Valve - appliances two independently zone: induction and gas

Hob with Flame power regulation by electronic touch system. Power levels of cooking Fully electronic safe system by double solenoid valve and ionization of burner sensor.



| | |
|-------------------|-------------------------|
| Number of burners | 2 |
| Dimension | 550x350x50 |
| Power | 1200-1500 W / SR 1.6 kW |
| Supply Gas | GPL 28-30 mbar |
| Supply Voltage | 220-240 V AC - 50/60 hz |
| Safety Device | Thermocouple |
| Weight | 10 Kg |

 PACKAGE DIMENSION
800X400X200 mm

 PACKAGE WEIGHT
12 Kg

 PACKAGES FOR PALLET
30 (120X120X180) 370 Kg

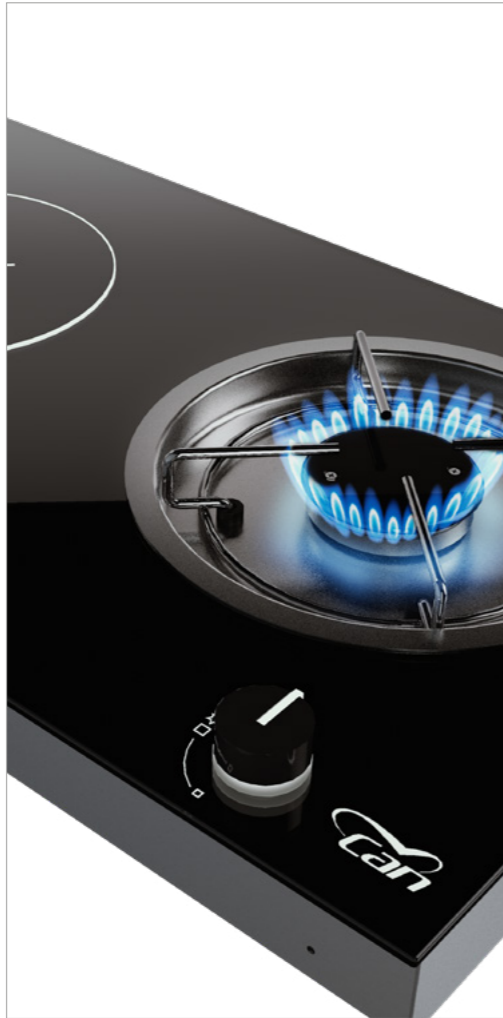

DISCOVER
MORE AT
AIRXCEL.EU



NEW FROM 2025!

HC0635T

Urban Hybrid Full touch - appliances two independently zone: induction and gas

Hob with Flame power regulation by electronic touch system. Power levels of cooking Fully electronic safe system by double solenoid valve and ionization of burner sensor.



| | |
|-------------------|-------------------------|
| Number of burners | 2 |
| Dimension | 635x350x50 |
| Power | 1200-1500 W / SR 1.6 kW |
| Supply Gas | GPL 28-30 mbar |
| Supply Voltage | 220-240 V AC - 50/60 hz |
| Safety Device | Thermocouple |
| Weight | 9 Kg |

 PACKAGE DIMENSION
800X400X200 mm

 PACKAGE WEIGHT
11 Kg

 PACKAGES FOR PALLET
30 (120X120X180) 340 Kg



DISCOVER
MORE AT
AIRXCEL.EU

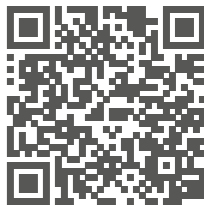

HC0770

Urban Hybrid 2+1 Gas Valve - appliances two independently zone: induction and gas

Hob with Flame power regulation by electronic touch system. Power levels of cooking Fully electronic safe system by double solenoid valve and ionization of burner sensor.



| | |
|-------------------|-------------------------|
| Number of burners | 3 |
| Dimension | 770x350x50 mm |
| Power | 1800 W / SR 1.6 kW |
| Supply Gas | GPL 28-30 mbar |
| Supply Voltage | 220-240 V AC - 50/60 hz |
| Safety Device | Thermocouple |
| Weight | 12 Kg |



PACKAGE DIMENSION
900X400X200 mm



PACKAGE WEIGHT
14 Kg



PACKAGES FOR PALLET
30 (120X120X180) 430 Kg



DISCOVER
MORE AT
AIRXCEL.EU



URBAN HYBRID FULL TOUCH - HC0635T

Cooktop and cut out dimension

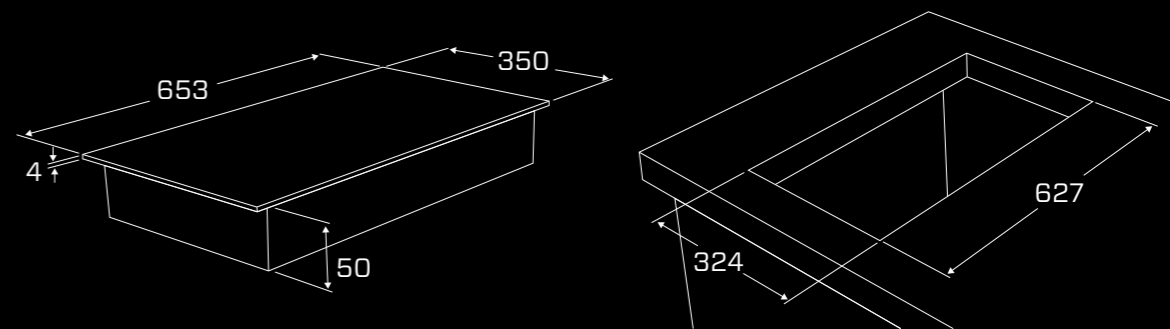

URBAN HYBRID 1+1 GAS VALVE - HC0550

Cooktop and cut out dimension

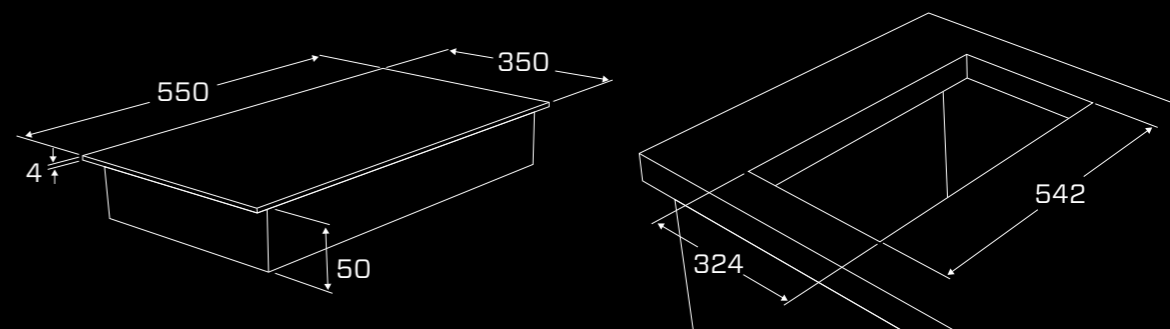

URBAN HYBRID 2+1 GAS VALVE - HC0770

Cooktop and cut out dimension

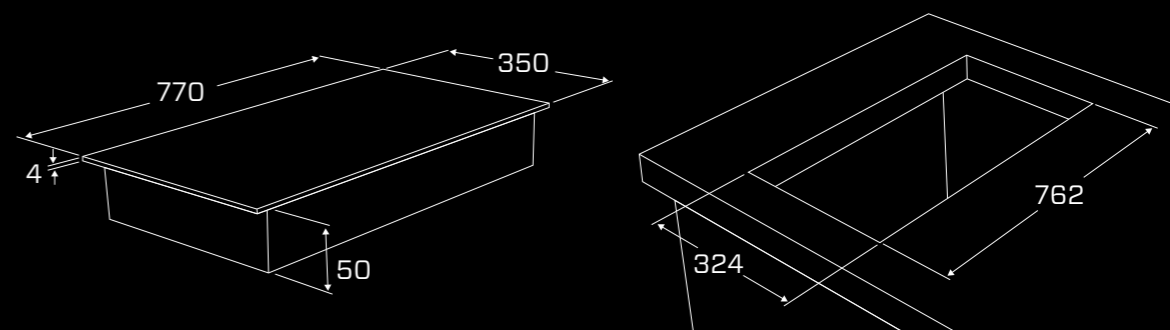

ACCESSORIES

The difference is in the details

It is a pan-holder that stabilises every item on the hob with a retractable tap and a seal that reduces vibrations. These are the details that make the difference. They are much more than just options, the accessories for CAN are the recipients of a particular research, making quality a really complete promise.

| | | | |
|--------|-----|--------|-----|
| LP1600 | 110 | RB1488 | 113 |
| LP1601 | 110 | RB1490 | 113 |
| LP1602 | 110 | RB1491 | 113 |
| LP1610 | 111 | RB1492 | 114 |
| LP1800 | 111 | RB1493 | 114 |
| LP1000 | 111 | RB1853 | 114 |
| RB1485 | 112 | LP5600 | 115 |
| RB1486 | 112 | LP5300 | 115 |
| RB1487 | 112 | LP5410 | 115 |



LP1600

Straight replacement drain with 1 1/4" plug.

| | |
|-----------------|---------------------------|
| Compatible with | All our products |
| Product size | Thread; 1 1/4" |
| Material | Plastic - Stainless Steel |

 **QUANTITY FOR PACKAGE**
100 PCS



LP1610

Straight replacement drain with 1 1/2" plug.

| | |
|-----------------|---------------------------|
| Compatible with | All our products |
| Product size | Thread; 1 1/2" |
| Material | Plastic - Stainless Steel |

 **QUANTITY FOR PACKAGE**
100 PCS



LP1601

Straight drain pipe \varnothing 25 mm with 1 1/4" thread.

| | |
|-----------------|--------------------------------------|
| Compatible with | LP1600 |
| Product size | \varnothing 25 mm - Thread: 1 1/4" |
| Material | Plastic |

 **QUANTITY FOR PACKAGE**
10 PCS



LP1800

Replacement drain with 1 1/4" plug, \varnothing 20-25 mm outlet.

| | |
|-----------------|--|
| Compatible with | All our products |
| Product size | \varnothing 20-25 mm, Thread: 1 1/4" |
| Material | Plastic - Stainless Steel |

 **QUANTITY FOR PACKAGE**
100 PCS



LP1602

90° \varnothing 25 mm drain pipe with 1 1/4" thread.

| | |
|-----------------|--------------------------------------|
| Compatible with | All our products |
| Product size | \varnothing 25 mm - Thread: 1 1/4" |
| Material | Plastic |

 **QUANTITY FOR PACKAGE**
10 PCS



LP1000

Universal 1 1/2" plug.

| | |
|-----------------|------------------|
| Compatible with | All our products |
| Product size | Plug: 1 1/2" |
| Material | Plastic |

 **QUANTITY FOR PACKAGE**
100 PCS



RB1485

Swivel mixer tap, double handle, in chrome-plated brass with ceramic valves.

| | |
|-------------------|---------------------|
| Installation Hole | 2 Holes Ø 18 mm |
| Product size | 180x78x158 mm |
| Material | Chrome-plated brass |
| Type of water | Hot and cold water |



QUANTITY FOR PACKAGE
10 PCS



RB1488

Chrome-plated plastic cold and hot water mixer tap, running on a 12 v microswitch.

| | |
|-------------------|-----------------------|
| Installation Hole | Ø 33 mm |
| Product size | 37x160x96 mm |
| Material | Chrome-plated plastic |
| Type of water | Hot and Cold water |



QUANTITY FOR PACKAGE
25 PCS



RB1486

Chrome-plated brass single gimbal tap with ceramic valves.

| | |
|-------------------|---------------------|
| Installation Hole | 2 Holes Ø 18 mm |
| Product size | 180x78x158 mm |
| Material | Chrome-plated brass |
| Type of water | Hot and cold water |



QUANTITY FOR PACKAGE
10 PCS



RB1490

Chrome-plated plastic folding cold water tap, running on a 12 v microswitch.

| | |
|-------------------|-----------------------|
| Installation Hole | Ø 22 mm |
| Product size | 191x150x97 mm |
| Material | Chrome-plated plastic |
| Type of water | Cold water |



QUANTITY FOR PACKAGE
30 PCS



RB1487

Chrome-plated plastic cold water tap, running on a 12 v microswitch.

| | |
|-------------------|-----------------------|
| Installation Hole | Ø 33 mm |
| Product size | 37x160x96 mm |
| Material | Chrome-plated plastic |
| Type of water | Cold water |



QUANTITY FOR PACKAGE
2 PCS



RB1491

Foldable chrome-plated plastic mixer tap, running on a 12 v microswitch.

| | |
|-------------------|-----------------------|
| Installation Hole | Ø 27 mm |
| Product size | 191x150x97 mm |
| Material | Chrome-plated plastic |
| Type of water | Hot and Cold water |



QUANTITY FOR PACKAGE
30 PCS

NEW!



RB1492

Foldable chrome-plated plastic mixer tap, short barrel, running on a 12 v microswitch.

| | |
|-------------------|-----------------------|
| Installation Hole | Ø 22 mm |
| Product size | 179x110x97 mm |
| Material | Chrome-plated plastic |
| Type of water | Cold water |

 **QUANTITY FOR PACKAGE**
40 PCS



LP5600

Drain plug with siphon.

Durable Materials: High-quality plastic, chrome finish.
Efficient Drainage System: Prevents clogs and odors.
Easy Installation: No special tools required, compact design.

| | |
|------------------|---------------------------|
| Compatible Pipes | 25 mm diameter |
| Mounting Hole | 60 mm diameter |
| Material | Plastic - Stainless Steel |

 **QUANTITY FOR PACKAGE**
50 PCS



RB1493

Foldable chrome-plated plastic mixer tap, short barrel, running on a 12 v microswitch.

| | |
|-------------------|-----------------------|
| Installation Hole | Ø 28 mm |
| Product size | 179x110x97 mm |
| Material | Chrome-plated plastic |
| Type of water | Hot and Cold water |

 **QUANTITY FOR PACKAGE**
40 PCS



LP5300

Drain with plug 90° angle hole 39 diam.25mm.

| | |
|------------------|---------------------------|
| Compatible Pipes | 25mm diameter |
| Mounting Hole | 39 mm diameter |
| Material | plastic - stainless steel |

 **QUANTITY FOR PACKAGE**
50 PCS



RB1853

Mixer tap with folding bridge pipe.

| | |
|-------------------|---------------------|
| Installation Hole | Ø 33.5 mm |
| Product size | 180x160x120 mm |
| Material | Chrome-plated brass |
| Type of water | Hot and Cold water |

 **QUANTITY FOR PACKAGE**
10 PCS



LP5410

Drain with plug 90° angle hole 39 diam.20mm.

| | |
|------------------|---------------------------|
| Compatible Pipes | 20 mm diameter |
| Mounting Hole | 39 mm diameter |
| Material | plastic - stainless steel |

 **QUANTITY FOR PACKAGE**
50 PCS



DISCOVER AIRXCEL EUROPEAN HEADQUARTERS



DISCOVER THE REST OF AIRXCEL WORLD

Airxcel Europe was established in 2019, with the acquisition of CAN Srl by Airxcel Inc. Like the US headquarters, the company's European division is specialised in the production of engineered components for RVs and environmental comfort systems.

Airxcel Europe is organized into several business units, each of which features top brands in their respective sectors: from air conditioning and heating to professional kitchen equipment.





AIRXCEL EUROPE CAN SRL

VIA APOLLONIO 11
36061 BASSANO DEL GRAPPA
(VI) - ITALY

+39 0424 1953311

INFO@AIRXCEL.EU

WWW.AIRXCEL.EU



@AIRXCEL.EUROPE



@AIRXCEL_EUROPE



@AIRXCEL_EUROPE

